

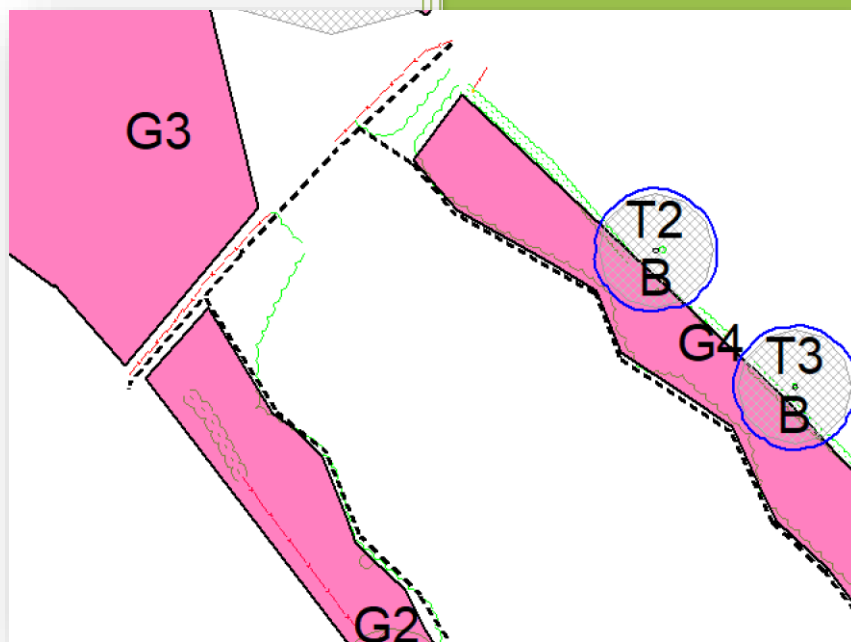

31/01/25

BS5837 2012 Tree Information – No 15 Ridgeway



**Site Address:**

15 Ridgeway  
Newport  
NP20 5AF

James Pinder Tech Cert (Arbor A)

[james@treecareconsulting.co.uk](mailto:james@treecareconsulting.co.uk)

07939 150 457

01633 882 890

## **Contents**

Contents.....	2
Site Location/descriptions .....	4
Report Limitations.....	5
Definitions.....	6
Avoiding damage to trees during construction .....	7
How to protect trees from preventable damage.....	9
Tree Protection Fences .....	9
Soils .....	10
Stripping/delivering soil .....	10
New soils to site .....	10
Ground Protection (if required) .....	11
Methods and specifications of paths using cellular confinement systems .....	12
Risk factors include .....	12
Compaction.....	12
Digging surfaces (site strip).....	12
No dig.....	12
Cellular Confinement and Backfill Material. ....	13
Surfacing Options.....	14
Block Paving: .....	14
Tarmac: .....	14
Loose Gravel:.....	14
Grass Blocks: .....	14
Site do and Don'ts.....	15
RPA dos & don'ts.....	15
Arboricultural Watching Brief (AWB).....	16
Tree Data.....	17
Minimum Arboricultural Method Statement – 15 Ridgeway .....	19
Site Monitoring by AWB.....	20
Arboricultural Implications Assessment – AIA (surveyor's overall thoughts).....	21
Tree Work List.....	23
Felling list .....	23
Pruning works .....	23

Coppicing works ..... 23

Transplanting works..... 23

Planting list..... 23

Data Sheets - site survey carried out - 28/01/2025..... 24

**Individual Trees Schedule:** ..... 24

**Groups of Trees Schedule:** ..... 25

Site Plans – Key ..... 26

Site Plan (Screen grab – please see scale pdf plan) ..... 27

## Site Location/descriptions



- I accessed the site from Ridgeway.
- The site is owned by my client.
- There are trees on site and the adjacent sites which could be affected by development activity.
- Some management recommendations have been made regarding trees due to age, form and long-term management/landscape.
- The grounds are laid out as private gardens.
- Mature shrub and small tree planting is on and around the site.
- Further planting could take place as a final landscaping scheme.

## **Report Limitations**

- Visual inspections from ground level unless otherwise indicated.
- No invasive inspection techniques used unless indicated.
- No underground excavations will have been performed unless otherwise indicated.
- No climbing or inspection at height will have been involved unless indicated.
- Report information expires after twelve calendar months from report issue date.
- Reports and information relating to them are the property of Treecare until paid for in full. Information within reports is retained at Treecare's discretion until paid for in full. Treecare will retract reports and comments from any due process if not paid for in full.
- Treecare will not create access to trees unless directed yet will undertake the accessing work if contracted to do so.
- Where access to a tree is not possible, best judgement/estimation will be used. Accurate information will therefore be minimal and will be checked at the earliest opportunity.
- Treecare only use suitably trained and knowledgeable persons for inspections holding the relevant qualifications for their purpose.
- Treecare has the right to remove employees from danger as they see fit.
- Verbal comments on buildings structural integrity are an opinion not fact (a structural engineer will be required for a detailed analysis).
- The diagrams and drawings provided by Treecare are not exact and should not be used for design purposes unless directed otherwise. They are however indicative of site features.
- Treecare will try their very best for the client. However, conflict of interest or professional judgement and character clashes must be accepted and resolved.
- Treecare's information and advice will only last as long as current legislation and current knowledge is up to date. Should new information supersede previous comments a new report must be issued.
- This is a preliminary report and further more detailed aspects may be required by the LPA or client at a later stage to define exact processes.

## **Definitions**

BS 5837 2012 (Trees in relation to construction) was revised in 2012 and now supersedes the previous 1991 & 2005 editions.

Within the newer BS many definitions are given so the professional arboriculturists are able to give an indication to planners and architects so that a common understanding of trees and how building new structures may affect the health and support of trees can be given.

### **Arboriculturist**

*A person who through relevant training, qualifications and experience in the arboricultural world is able to form an opinion on how trees may be affected through development processes.*

### **Competent person**

*A person, who has had training and experience relevant to the matter in hand and is able to recognize whether it is safe to proceed with a specific site process.*

### **Structure**

*Man-made object, such as a building, carriageway, path, wall, services and built or excavated earthworks.*

### **Root protection area (RPA)**

*A site layout design tool that enables a pictorial representation of trees required rooting area. This area must be protected to ensure the survival of trees.*

### **Tree constraints plan (TCP)**

*A clear plan diagram showing tree locations, crown spreads and rooting areas. This allows the arboriculturist to demonstrate areas where trees will affect a proposal by tree volume, height or shade.*

### **Construction exclusion zone (CEZ)**

*An area clearly marked both on site and on a site plan. This area must have no construction operations carried out within.*

### **Tree protection plan (TPP)**

*A scale drawing that shows tree locations, rooting areas and fencing locations on site.*

### **Arboricultural implications assessment (AIA)**

*An assessment made by the arborist to identify, evaluate and possibly mitigate effects of construction process on trees.*

### **Arboricultural method statement (AMS)**

*A written or toolbox talk applied method of ensuring the contractor (construction) can implement the design adjacent to existing trees.*

### **Services**

*Above or below ground pipe work, wire or ducting construction that could affect trees crowns or their roots or rooting areas.*

### **Special engineering**

*Designing of a structure with the physiological requirements of trees as the primary concern.*

## Avoiding damage to trees during construction

The flow diagram below shows the process that should be followed to help prevent any risk of damaging trees during the design and construction process and due consideration to retained trees and roots is given. Where any confusion lies or something noted is not understood it is important that the query is resolved before proceeding.

The arboriculturist should be consulted and, as a minimum a verbal discussion must take place in order to clarify any detail that is misunderstood.

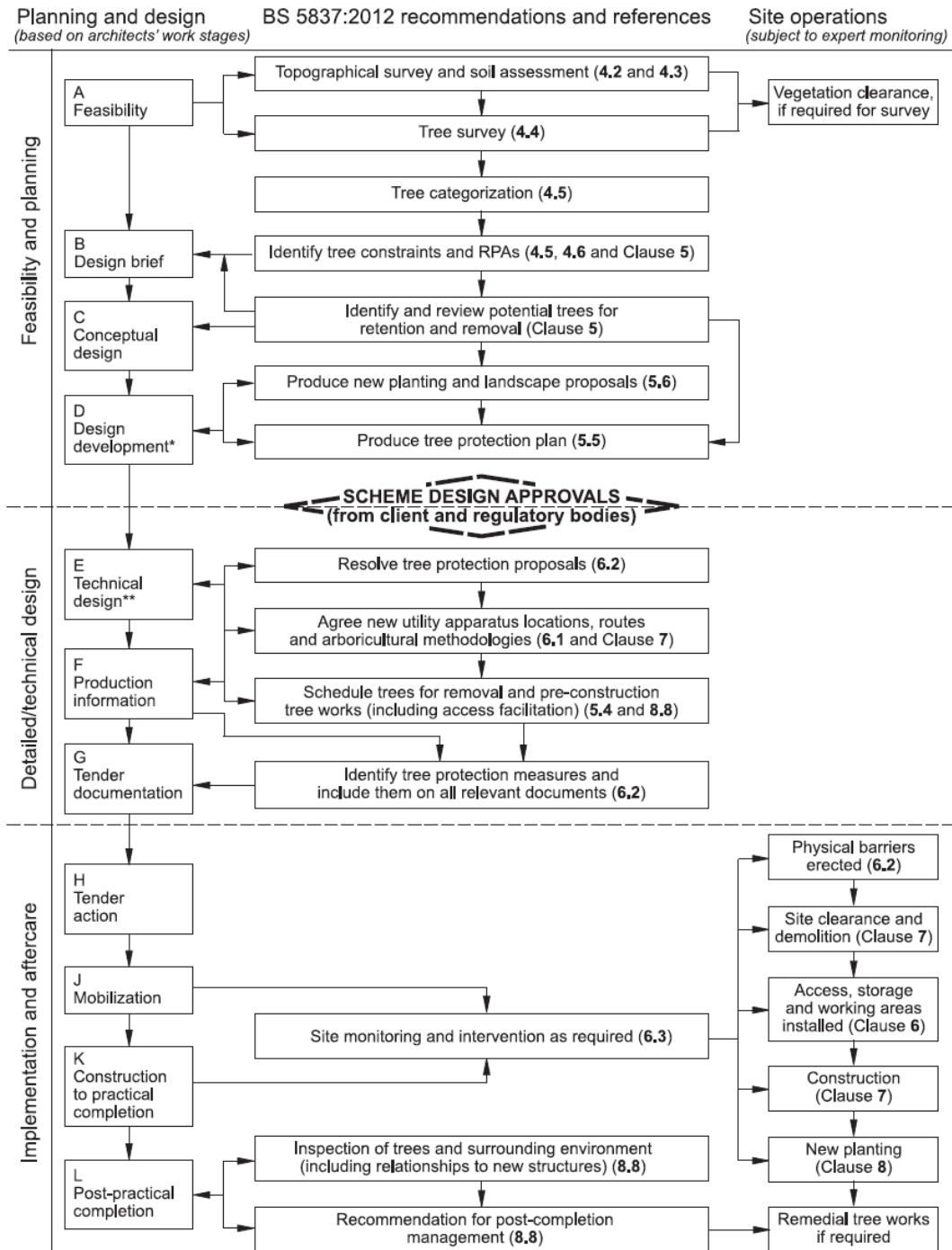

Trees on development sites are commonly destroyed by plant equipment operators feeling that their own experience of trees outweighs the knowledge and experience of the arboriculturist. In my opinion this would be a very rare occurrence.

Damage occurs by many differing ways. There is indirect and direct damage. The first takes time to have an effect on long term tree health unless toxic substances are involved, the latter can be instant but can lead to a drop in tree value or create a wound a tree finds difficult to defend.

Compaction of soils can cause many problems for trees and must be avoided at all costs. The compaction of a soil will remove the pore spaces between soil particles and thus remove oxygen from the soil that the tree would use for respiration. This then means that the tree will slowly but surely decline as it is suffocated.



This photo shows a combination of damage. The roots have been severed or damaged in such a way that stability has been lost and this tree was felled. If the same damage had not led to an immediate tree failure the tree would have been sent into an irreversible spiral of decline.

The loss of roots will have caused a lack of structural support, loss of moisture take-up, loss of oxygen take-up and a means of the tree storing energy as starch within root structures. This type of root damage causes a slow decline in tree foliage known as crown die back.

The picture to the right shows the die back of foliage several years after the completion of a development site. Machine operators will often mention how they have dug roots or driven over them. This is what happens once they leave site.



Trees have to have roots in order to perform their most basic but important tasks. To the tree the root system is more important than the crown. However, the crown is more important to us as it is the part we can see.

The only way to avoid needless destruction is to give them the space they require and provide adequate protection from construction process.

If adequate protection is not given the disaster below is not far behind!



## How to protect trees from preventable damage

### Tree Protection Fences

The BS document provides various diagrams on how to protect tree rooting areas. The fence needs to be erected prior to construction traffic site occupation and often with the arboriculturist present to ensure correct placing. Types for hard and soft ground surfaces are shown below.

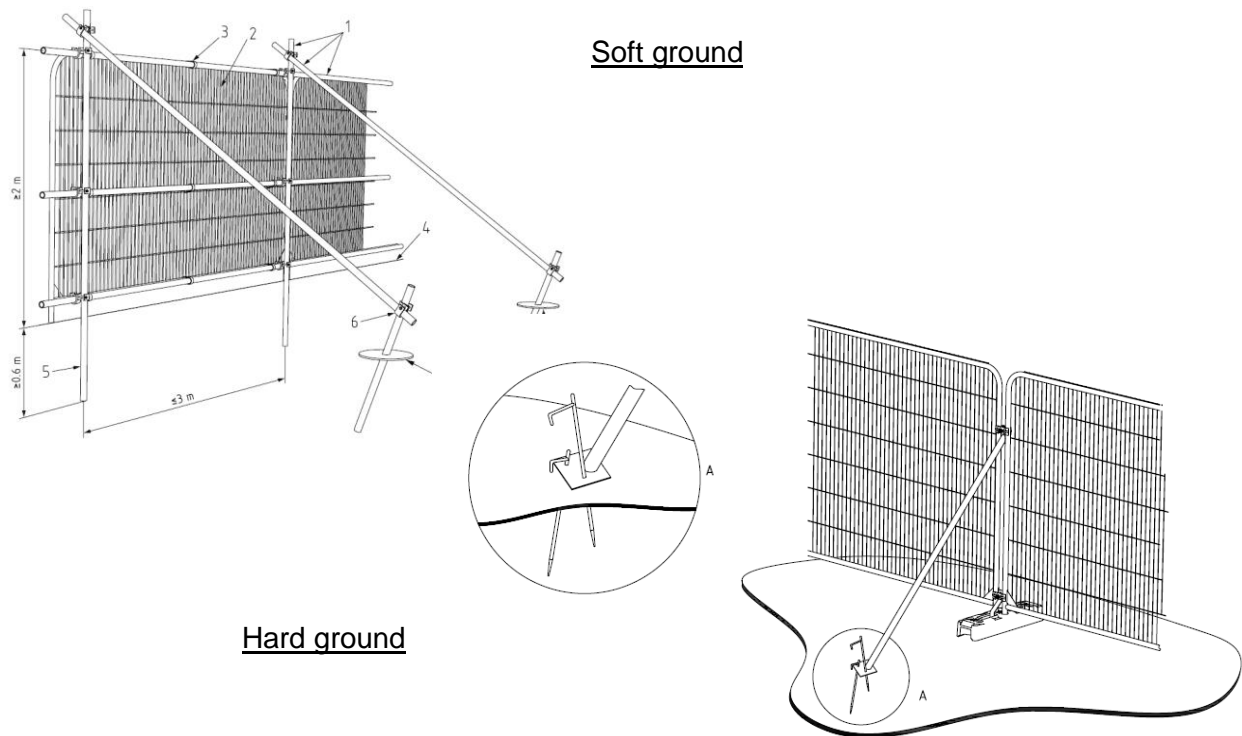

The rooting area is calculated by using a stem measurement. For single stems trees the diameter if the stem is measured at 1.5m above ground level or point of even stem taper. This figure, in millimeters is then multiplied by twelve and this will then give the radial measurement from the stem to the edge of the rooting area. A circular area is created around the tree at the radial measurement. This is where the fencing should be located. Multi stemmed trees now require average stem size calculations based on 2-5 stems or 5+ stems. Contact the arboriculturist if in any doubt.

The design of RPA or CEZ fencing should be so that it cannot be moved during works. It must also be robust enough to withstand minor knocks and scrapes from plant equipment. The fence must be in place prior to site occupation by plant equipment and should be removed once the site has been vacated by construction traffic. Should there be a requirement to place pedestrian walkways across and RPA a suitable method of ground protection should be used. A geo textile layer, compressible material and then boards should suffice as a walkway. This specification will need to be agreed by the arboriculturist prior to installation. It should also be laid in front of the direction of travel during installation. All hedges and trees over 150mm diameter at 1.5m need root protection. If no RPA measurement is provided for a tree or hedge requiring root protection ensure the fence is set 2m from the outer edge of the tree/hedge drip line.

**Fences will require clear signage as to purpose – Tree Protection Fencing.**

## **Soils**

Chapter 6 of BS 3998 2010 (British Standard for Treework) explains that adverse and sudden changes to soil structure, nutrient, oxygen and hydrology can have catastrophic outcomes for trees. Steps must be taken to protect the soils within a rooting area where retained tree roots are present. It is crucial to tree survival that soils are not altered.

A basic tactile assessment of soils by hand has been made of the site soil structures. Common soils are found to be present on site but soil condition can always be improved upon. Soil improving ameliorants can be found in Annex B, Table B2 of BS 3998 2010 where recommendations are made to improve soils on site.

BS3998 2010 advises the use of soil mulches such as woodchip and leaf mould for improving soils around trees. It is advisable that where suitable, woody material being removed from site is turned into a woodchip mulch and applied to rooting areas. This mulch improves worm activity thus increasing oxygen levels plus it adds vital nutrients to the soil environment. Mulches also help retain soil moisture levels and as such help promote growth and development in retained trees.

## **Stripping/delivering soil**

Stripped or delivered soil to site must be stored as follows:

- Loose tipped.
- Away from contaminants.
- Clearly marked to future use.
- Foreign bodies removed.

## **New soils to site**

- Planting pits will be new construction of the appropriate soil volume as requested by the LPA.
- Soils must be handled according to good practice as laid out in BS3882:2007 and the DEFRA code (2009).
- Imported soils will be used for the planting pit. (The ideal planting soil contains approximately 45% mineral solids, 5% organic mineral solids and 25% each water and air, as shown in Figure B.1.BS8545).
- Planting pits to only contain imported top quality planting soil/top soil mix at upper 400mm depth only, in accordance with the specifications laid out in BS3882:2007.
- Soils below 400mm must be suitable sub soil as specified by BS3882:2007 and BS8545.
- All soils used in the planting pit soil must have a certificate of compliance from the soil supplier that also states the volumes supplied.

## **Ground Protection (if required)**

Existing soil structure and texture must not be destroyed or altered in the vicinity of trees and rooting areas. Future planting sites should also have their structure preserved by the use of ground protecting plates. This will allow mechanical plant to move around the site and transit areas of high root occupancy or planting sites of high value without damaging important soils.



The use of ground protecting boards such as these seen in the adjacent picture should be used. Geo textile and felt may be required beneath these routes to minimize puddling of the soil surface. Should puddling occur, a capped layer may well be formed which will reduce the lateral diffusion of soil gasses and cause significant problems for retained trees.

A non-compressible layer such as woodchip should be used under-ground protection whenever there is a need for it to be in place for more than three days.

Any ground protection must be capable of withstanding the load placed upon it. An engineer must be consulted for advice on the specification of such protection if required for the area if high loads are to be expected.

Another method of ground protection for light operations such as pedestrian activity can be utilized by using the installation of raised platforms mounted onto scaffold legs.

Platforms such as these could be used for light storage, walkways or as an area for construction workers to stand whilst carrying out operations such as block laying and pointing. Water proof sheeting on top of the boarding should be used to catch any material that could leach into soils where tree roots are present or run off could reach.

Particular attention should always be made when using ground protection to surface run off. Fuel oils, cement and water with high fines content are all very damaging to trees. Provision must be made to ensure that run off does not leach into soils.

Temporary track ways can also be constructed by using geo textile onto top of the ground and type 1 road stone with no fines be used as the surface. This method must only be used at the outer limits of an RPA.

## **Methods and specifications of paths using cellular confinement systems**

When considering possible damage to tree roots during the applications of vehicular access and parking, the risk to trees is from oxygen depletion caused by compaction of subsoils and site clearance work damaging the soil structure and roots below ground.

This damage may well lead to tree failure and can be traced back to the contractor responsible for liability claims.



### **Risk factors include**

Creating an impermeable surface  
Causing a rise in the water table due to construction  
Increasing ground level  
Contamination of subsoil's

### **Compaction**

When looking at site conditions and use, the following information should be considered to enable a load bearing structure capable of supporting traffic to be proposed:

Californian Bearing ratio (CBR) – Standard test method for measuring soil strength  
Soil types  
Water table  
Maximum load (vehicles)  
Acceptable rut depth

Reinforcement type - Cellular Confinement  
Type and Depth of engineered infill material - Clean, angular. Usually, 40mm to 20mm.

### **Digging surfaces (site strip)**

Site stripping does damage root structures present prior to construction; however, the use of no-dig construction elevates the access road requiring edge protection.

### **No dig**

1. Remove surface vegetation  
Use a suitable herbicide suitable for the specific vegetation and not harmful to the tree root system.
2. Place geo textile separation filtration layer  
Use a Fibretex F4M non-woven Geo textile over the prepared sub-grade. Overlap dry joints by 300mm.
3. Cellular Confinement System  
The three-dimensional cell structure, is formed by ultrasonically welding polyethylene (perforated) strips / panels together to create a three-dimensional network of interconnecting

cells. A high degree of frictional interaction is developed between infill and the cell wall, increasing the stiffness of the system.

#### 4. Edge restraint

A treated timber edging is usually acceptable.

### **Cellular Confinement and Backfill Material.**

Expand the confinement systems 2.56m wide panels to the full 8.1m length. Pin the panels with staking pins to anchor open the cells and staple adjacent panels together to create a continuous mattress. Infill the cells with a no fines angular granular fill (typically 40-20mm) within each open cell. The use of cellular confinement reduces the bearing pressure on the subsoil by stabilizing aggregate surfaces against rutting under wheel loads. Comparisons between cellular confinement and traditional aggregate and geo grid-reinforced structures demonstrate a 50% reduction in construction thickness of the granular material.



## **Surfacing Options**

### **Block Paving:**

1. Lay second layer of Fibretex F4M Geo textile separation fabric over the filled confinement sections.
2. Lay sharp sand bedding layer compacted with a compaction plate to recommended depth to consolidate but not compact.
3. Lay block pavers as per manufacturer's instructions.

### **Tarmac:**

Place 25mm layer of the granular material above the confinement system and lay the bitumen base and wearing courses.

### **Loose Gravel:**

1. Place second layer of Fibretex F4M Geo textile separation fabric over the filled confinement sections.
2. Place decorative aggregate to required depth.

NOTE: A treated timber edge should be provided to restrict gravel movement.

### **Grass Blocks:**

1. Place second layer of Fibretex F4M Geo textile separation fabric over the filled confinement sections.
2. Place 50/50 root zone bedding layer to the required depth.
3. Lay recycled Duo Block 500 Grass Protection System filled with 50/50 root zone mix.
4. Seed as per architect's instructions.
5. (Alternatively, the Grass Blocks may be filled with gravel.)

Below are illustrations of the correct stapling procedure for joining both edges and ends of panels together;

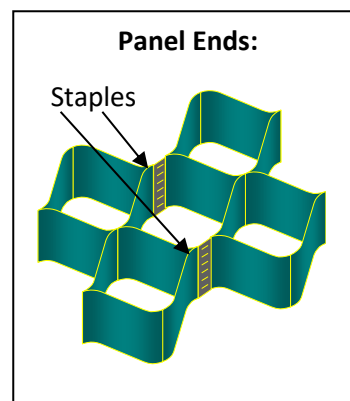
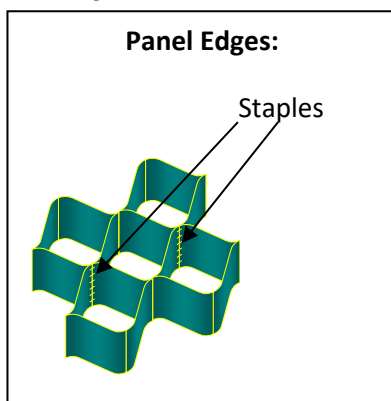

## **Site do and Don'ts**

- Do not occupy ground space within the crown spread of a tree.
  - Do not work without suitable protection fencing around retained trees.
  - Do not travel the site without suitable ground protection where roots exist.
  - Do not break the ground near trees unless being supervised by a competent person in tree care and management.
  - Do not allow builders sand to be placed near rooting areas as this is toxic to trees.
  - Do not store fuels, cement or other toxic materials near trees.
  - Do not light fires within 15m of a tree crown.
  - Do not trench through roots above 10mm in diameter unless under direct supervision by an arboriculturist.
  - Do not lean objects against tree stems or branches.
  - Do not tie ropes or cables to trees unless during a temporary and authorized task.
  - Do not allow plant equipment to make contact with any part of trees.
  - Do not allow exhaust pipes to be directed at trees and shrubs.
  - Do not place service or drain runs through an RPA.
- 
- ✓ Do discuss site operations with an arboriculturist.
  - ✓ Do use toolbox talks to inform staff on site of the tree's needs.
  - ✓ Do liaise with the planning officer regularly to ensure full compliance at all times.
  - ✓ Do erect barriers such as RPA and CEZ fencing early.

## **RPA dos & don'ts**



*Don't use site vehicles within the root system, this will compact the soil and can lead to root suffocation.*



*Don't store poisons, chemicals, fuel, diesel, oil or cement beneath a tree. Don't light fires.*

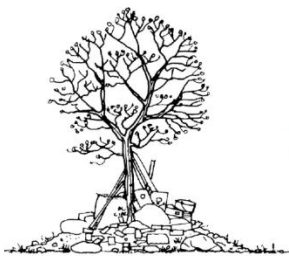

*Don't store or deposit building materials against or beneath a tree.*

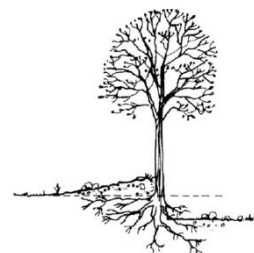

*Excavations will damage roots, whilst increasing levels will exclude air vital for healthy roots.*

## **Arboricultural Watching Brief (AWB)**

When adequate tree protection and suitable distances to trees and rooting areas can be put in place on site, there is often no need for an Arboricultural Watching Brief (AWB). However, when the design dictates that work may be required in an area of sensitivity in regard to trees and rooting areas, an AWB may be required. You may also find that a planning authority places a planning condition on using an AWB on certain aspects of work.

It is strongly advised that you utilise the knowledge of your site arboriculturist/AWB. This advice should start to take place prior to any design ideas being formed. This can save many issues in regards to design and planning issues as you will know what will fit on site or not in relation to retained trees.

Common items where an AWB may be required:

- Installation of Tree Protection Fences.
- Movement of Tree Protection Fences.
- Work within or close to a tree RPA.
- Installation of piles within an RPA.
- Installation of temporary ground protection in or near tree rooting areas.
- Certain pruning needs for trees – specific and sensitive pruning.
- Excavation adjacent to rooting areas.
- Supervised hand or air spade work within a root protection area.
- Installation of ducting within a rooting area.
- Grading/blending of a bank batter to/from rooting area extremity.
- Overseeing soil nibbling to record the true extent of a rooting area radius.
- New planting locations. Locations and species selection.
- Crane operations past tree canopies.
- Removal of tree protection fences upon discharge of tree protection conditions for the site.
- Final landscaping and soil coverings from new back into existing soils/rooting areas.

The AWB is not there to hinder work but to advise on the best way forward to aid the project. This advice is based on known issues, experience and requirements of planning legislation.

Please feel free to ask JPTC any questions that you feel may require the use of and AWB. Most issues are easily resolved well before any damage to retained trees occurs if the advice is sought at an appropriate stage.

## **Tree Data**

It is often essential to gain the tree information for the site first and then design the site around what the tree cover (following Arboricultural management work) allows.

A site's use can be maximised if the plans are drawn after the vegetation/tree survey is complete. This is to allow the architect to see exactly what area is available for development. A design which is correct and that fits the landscape, without causing significant disruption would then be achievable. This is particularly important if protected trees or trees of very high value are present. It is also far more likely to be accepted in the planning process.

Within the data captured on site, any immediate tree management work is also noted within the schedule of findings. This work is to help trees with minor problems and to increase site safety to construction workers and the new occupiers of the site following development.

The table on the following page is the cascade chart as per BS5837 2012 for capturing consistent tree data whilst carrying out development-based tree surveys. It allows for trees to be clearly seen by the planning process with a standardised, alpha numerical grading system. The alphabetical system also allows a colour coded approach to see the trees marked on a site plan according to its category (A, B, C & U). It is important to show tree canopy spreads in these standard colours, green, mid-blue, grey and red. Groups are shown as a pink area by JPTC.

Each tree/group is assessed to identify its species, capture its physical dimensions, assess its physiological health and assess its structural condition. Further assessment is made to how the tree is suited to the location where the proposed design is already known.

Trees which are in decline but have useful life left such as veteran trees are also included. This allows for them to be kept on sites where possible because of the high ecological, historic and cultural benefits they may bring to the locality. It is important to remember that these trees may be in excess of one hundred years old and their loss to the area could be dramatic for hydrology, ecology and landscape features not immediately obvious when stood on site.

The construction company's name is on the site, how the site is left, is how the site will be remembered. Trees may appear to be a nuisance to development processes but they should not be overlooked as they can add value to a site and reduce the future landscaping needs and associated costs.

Key to tree data classifications overleaf:

A separate large-scale version of this can be made available should it be required.

**Table 1 Cascade chart for tree quality assessment**

Category and definition	Criteria (including subcategories where appropriate)			Identification on plan
<b>Trees unsuitable for retention (see Note)</b>				
<b>Category U</b> Those in such a condition that they cannot realistically be retained as living trees in the context of the current land use for longer than 10 years	<ul style="list-style-type: none"> <li>Trees that have a serious, irremediable, structural defect, such that their early loss is expected due to collapse, including those that will become unviable after removal of other category U trees (e.g. where, for whatever reason, the loss of companion shelter cannot be mitigated by pruning)</li> <li>Trees that are dead or are showing signs of significant, immediate, and irreversible overall decline</li> <li>Trees infected with pathogens of significance to the health and/or safety of other trees nearby, or very low quality trees suppressing adjacent trees of better quality</li> </ul> <p><i>NOTE Category U trees can have existing or potential conservation value which it might be desirable to preserve; see 4.5.7.</i></p>			See Table 2
	1 Mainly arboricultural qualities	2 Mainly landscape qualities	3 Mainly cultural values, including conservation	
<b>Trees to be considered for retention</b>				
<b>Category A</b> Trees of high quality with an estimated remaining life expectancy of at least 40 years	Trees that are particularly good examples of their species, especially if rare or unusual; or those that are essential components of groups or formal or semi-formal arboricultural features (e.g. the dominant and/or principal trees within an avenue)	Trees, groups or woodlands of particular visual importance as arboricultural and/or landscape features	Trees, groups or woodlands of significant conservation, historical, commemorative or other value (e.g. veteran trees or wood-pasture)	See Table 2
<b>Category B</b> Trees of moderate quality with an estimated remaining life expectancy of at least 20 years	Trees that might be included in category A, but are downgraded because of impaired condition (e.g. presence of significant though remediable defects, including unsympathetic past management and storm damage), such that they are unlikely to be suitable for retention for beyond 40 years; or trees lacking the special quality necessary to merit the category A designation	Trees present in numbers, usually growing as groups or woodlands, such that they attract a higher collective rating than they might as individuals; or trees occurring as collectives but situated so as to make little visual contribution to the wider locality	Trees with material conservation or other cultural value	See Table 2
<b>Category C</b> Trees of low quality with an estimated remaining life expectancy of at least 10 years, or young trees with a stem diameter below 150 mm	Unremarkable trees of very limited merit or such impaired condition that they do not qualify in higher categories	Trees present in groups or woodlands, but without this conferring on them significantly greater collective landscape value; and/or trees offering low or only temporary/transient landscape benefits	Trees with no material conservation or other cultural value	See Table 2

## **Minimum Arboricultural Method Statement – 15 Ridgeway**

**The list below must be in place before any development activity occurs on site, if in doubt ask, do not assume or carry on regardless.**

1. **Before any construction plant equipment, vehicles and associated activities start** on site, carry out preliminary tree pruning/management works as listed within the tree schedules within this document subject to permissions from LPA – check for type, size and access for tree equipment to be used – get written approval from LPA for use. Permission will be required in writing from an LPA for trees subject to tree preservation orders and conservation areas - 211 notifications made if applicable if the area is a conservation area. Trees subject to a TPO also include the root system of the tree and soils in the vicinity of the tree.
2. No mechanical plant equipment is to access retained tree RPAs areas (marked as grey hatching) as noted on the site plan at the rear of this document at any stage – ground protection must be used and advice from an arboricultural watching brief advised if roots are under access routes. The same equipment/personnel must not use the construction exclusion zones. Storage of materials is also not allowed in the CEZ or tree RPAs or in a location where run-off can enter tree occupied soils.
3. Layout suitable rooting area and tree structure protection fences in accordance with BS5837 2012 or as type agreed by the LPA around retained tree's rooting areas, as defined in this document on the site plan. This temporary fence must remain until the LPA discharge the condition for the use of Tree Protection Fencing.
4. Mark RPA fences clearly to their intended use –

### **“Construction Exclusion Zone (CEZ) KEEP OUT”**

These fences, once installed, must not be altered or moved without written permission.

5. No development work should take place within a theoretical rooting area of trees as defined by BS5837 2012 on site. Ample working room should be made available on site outside of RPA fences as a buffer zone.  
No roots should be cut in excess of 10mm – seek immediate arboricultural advice if roots are found outside an RPA.
6. Protect all trees large and small plus future planting locations from development processes until the LPA discharge the tree protection condition.
7. Always use or seek the advice of the arboricultural watching brief if working adjacent to RPAs, lifting hard surfaces with possible roots below, working within 10m of a tree, woodland or tree group.
8. Ensure hedges have at least half their height available as a distance for an RPA.
9. Ensure any specific detailed AMS/toolbox talk details are written as required and signed off by LPA before undertaking any work.

## **Site Monitoring by AWB**

In many cases the LPA will insist on site monitoring by the site arboriculturist at the site owner/project construction companies own cost, the results of which must be sent to the LPA within 72 hours of each visit.

By not carrying out conditioned site monitoring you will be in breach of your planning conditions and the condition cannot be discharged until you meet the condition on completion of all development work on site – impossible to do if frequent checks/records are not in place. The site monitoring needs to be tailored to the site. JPTC use the following list of headings with which to create the site monitoring sheet which can be sent to the LPA.

**Site Address:**

**POC:**

**Date:**

**Trees on or off site:**

**Timings/visit chronology:**

1. Pre start visit.
2. Tree Protection Fencing in place – AWB check, photos to LPA to be agreed and signed off.
3. Site occupation by contractor.
4. Monthly checks.
5. Completion of all works with a risk to trees.
6. Tree Protection Fencing removal/Tree Protection Fencing condition discharge.

### **Checks**

- Tree protection (RPA) fences in place:
- RPA Fence signage fitted:
- Evidence of movement or tampering:
- RPA Fences at correct distances to tree stems:
- Service installations not affecting trees:
- Groundwork completed:
- Tree work completed:
- Materials stored away from RPA's and CEZs:
- Specific planning condition requirements met:

### **Summary**

A summary of the findings on site.

### **Photos from site**

Photographs to use as pictorial evidence that the above records are true and correct.

## **Arboricultural Implications Assessment – AIA (surveyor’s overall thoughts)**

This AIA has been written by the tree surveyor for the site and is based upon tree condition, relationship to the site and potential future use or simply to explain obvious arboricultural constraints, tree threats or management issues – discussion that is useful for the Tree Officer looking at the application and also the architect/site manager. Page 7 in this document should be read and understood. It is strongly recommended that arb input occurs in the layout process to avoid planning issues regarding trees at a later stage.

Site monitoring will be required as per page 21 of this document. This should include and pre start meeting, Tree Protection Fence install, mid-point and end point visits with the findings of each visit sent to the LPA.

1. T1 is a mature oak tree situated beyond the rear boundary line of the site within the protected woodland. The trees rooting area is not influenced by the site. No alterations to the tree are required.
2. T2 and T3 are off site birch species trees within an adjacent garden. Their rooting areas will need to be considered on site. Protection of the rooting area can be achieved simply by retaining the mature boundary planting (G4) along this side of the site as a natural buffer zone and visual screen.
3. T4 is a street tree lime pollard belonging to Newport City Council. The pollarding of the tree by NCC suggests a potential low stem defect. Negotiating with NCC could enable a replacement younger lime tree within the verge at a greater distance from the site access. This would benefit the street tree planting and the replacement tree could be located centrally in the soft verge meaning increased visual splay and a longer-term safe street tree within the verge.
4. T5 is a further street tree lime belonging to Newport City Council. No obvious defects are recorded. The tree’s rooting area may interfere with services running past and into the existing site. Careful exploration and documentation of this area will be required to assess the influence of any changes on the trees rooting area. Shade cast by T5 does not affect potential build areas.
5. G1 is an adjacent cypress hedge. This hedge is in separate ownership and is highly likely to be retained by the owner as a visual screen. The rooting area for the hedge will extend into site so any new access should factor this in. Further ground assessments for exact rooting extent within the site should take place.
6. G2 is a linear boundary shrub bed of mixed species. It may be possible to undertake localised pruning to reduce overall bed width but the length should be retained and the bed utilised as a soft landscape buffer and tree protection zone for trees and shrubs along the boundary.
7. G3 is a protected woodland area. No trees are in close proximity to the site. It may be possible to utilise a natural clearing area in G3 for an attenuation pond location for surface water – ecological and pond advice should be sought. This feature must have no impact on T1. AWB should be used to indicate a suitable location away from mature trees in the protected woodland.
8. G4 and G5 are also mature shrub beds along boundaries. These could also be trimmed but ideally should not be removed and should be retained and the bed utilised as a soft landscape buffer and tree protection zone for trees and shrubs along the boundary.

- 9.** There were a number of stumps noted on site of felled trees. In nearly all of the stumps on site, there were obvious signs of major defects. These defects are cavities/hollowing, decay/rot and other basal defects. Their loss was inevitable.
- 10.** Natural self-set regeneration will occur within G3. This regeneration will replace any perceived loss of trees locally and bolster the protected woodland tree stock numbers.

## **Tree Work List**

### **Felling list**

None.

### **Pruning works**

G2, G4 and G5 potentially.

### **Coppicing works**

None.

### **Transplanting works**

None.

### **Planting list**

TBC. Garden will be able to have new planting within them as required but overplanting should be avoided.

**Data Sheets - site survey carried out - 28/01/2025**

The following data tables contain specific tree dimensions that are used to calculate the relevant protection from development. This protection is to ensure the long-term survival of retained trees. Should any questions arise please contact Treecare Consulting.

**Individual Trees Schedule:**

Tree Number	Species	Height	Tag Number	Spread N - E - S - W	Low Limb Height	Low Limb Direction	Stems	Diameter @ 1.5m in MM	Structural Condition	Physiological Condition	Noted defects	Management Recommendations	Age Class	Years Remaining	Tree Quality	Tree Value	AMS Comment
T1	Oak. Off site	20	None	8 8 8 8	4	NE	1	1000	Normal for species	Normal for species	No significant defects in relation to site	None. Off site	Mature	40+	A High Quality	3 Cultural/Conservation	Off site tree. Rooting area has no connection to site
T2	Birch off site	17	None	4 4 4 4	5	All round	1	300	Normal for species	Normal for species	Historical pruning/topping outgrown	None	Mature	20+	B Moderate Quality	1 Arb Values	Off site tree. Rooting area potential in site
T3	Birch off site	17	None	4 4 4 4	6	All round	1	300	Normal for species	Normal for species	Historical pruning/topping outgrown	Hung up dead branch	Mature	20+	B Moderate Quality	1 Arb Values	Off site tree. Rooting area potential in site
T4	Lime off site NCC	7	1404	3 3 3 3	5	All round	1	750	Normal for species	Normal for species	No significant defects in relation to site	None	Mature	40+	A High Quality	3 Cultural/Conservation	Off site tree. Rooting area has no connection to site but roots will be in the vicinity of any access alterations
T5	Lime off site NCC	17	None	5 5 5 5	5	All round	1	470	Normal for species	Normal for species	No significant defects in relation to site	None	Mature	40+	A High Quality	2 Landscape value	Off site tree. Rooting area has no connection to site but roots will be in the vicinity of any access alterations

15 Ridgeway

**Groups of Trees Schedule:**

Group Number	Species	Low Limb Height	Low Limb Direction	Average group height	Expected RPA (stem to fence M)	Prelim RPA fence locations	Structural Condition	Physiological Condition	Noted defects	Management Recommendations	Age Class	Years Remaining	Tree Quality	Tree Value	AMS Comment
G1	Cypress off site	Ground level	All round	6	3	2	Normal for species	Normal for species	Proximity to boundary. Roots likely to be in site	None	Mature	20+	C Low Quality	2 Landscape value	AWB required for hard surface removals. Leave 2m buffer to boundary. TPP fence.
G2	Mixed shrubs	Ground level	All round	3	1	Follow feature edge	Normal for species	Normal for species	Retain group as instant mature boundary planting	None. Ongoing maintenance.	Mature	20+	B Moderate Quality	3 Cultural/Conservation	Leave 1m buffer to bed. TPP fence.
G3	Mixed woodland	Ground level	All round	18	6	Follow feature edge	Characteristic defect	Normal for species	None in relation to the project	None	Mixed	40+	A High Quality	2 Landscape value	No access to woodland. No trees with RPA boundary conflicts
G4	Mixed shrubs	Ground level	All round	3	4	Follow feature edge	Normal for species	Normal for species	Retain group as instant mature boundary planting	None. Ongoing maintenance.	Mature	20+	C Low Quality	3 Cultural/Conservation	4-m buffer zone required to boundary due to off site birches over boundary fence
G5	Mixed low shrubs	Ground level	All round	1	1	Follow feature edge	Normal for species	Normal for species	None in relation to the project	None	Mature	10+	C Low Quality	3 Cultural/Conservation	No comment

## Site Plans – Key

Scale plans can be sent as PDF files if required. The plans are to indicate locations of trees, locations of main objects on site and the location of tree protection fencing. Stem diameters found in tree and tree group data tables should be used to mark out the location of root protection fencing on site.

**Dark Red U = trees requiring removal due to condition/grade.**

**Grey = C Class trees (low value).**

**Blue = B Class trees (moderate value).**

**Green = A Class trees (high value).**

**Grey hatched area = Root protection areas (RPA).**

**Black dash line = Tree protective fence locations.**

**Shade quadrants = Hatched grey fan area.**

*ALL SITE PLANS CAN BE PRINTED AS A3 OR BE SENT AS DXF FILES. ALTERNATIVELY THE CSV FILE CAN BE EMAILED WITH TREE DATA ON.*

**Site Plan** (Screen grab – please see scale pdf plan)

