

APPENDIX 9.4

**Geotechnical & Geo-environmental Site
Investigation Report:**

Proposed Residential Development
Herbert Road
Newport

Phase 1

Prepared For:
Keepmoat

February 2017

Job No: 12032P1



terrafirma

REPORT TITLE : **Geotechnical and Geoenvironmental Report Site Investigation Report:**
Proposed Residential Development, Herbert Road, Newport

Phase 1

REPORT STATUS : **Final**

JOB NUMBER : **12032P1**

DATE : **February 2017**

PREPARED BY : 
.....
Mrs Ruth Howells

REVIEWED BY : 
.....
Mathew Lake

APPROVED BY : 
.....
Dr Gwyn C Lake

Executive Summary

| | |
|---|---|
| Site Location | <i>The site is situated along the River Usk, Newport. It primarily comprises rough grassland along the River Usk intersected by a tarmac footpath, but part extends onto the main area of the development site, alongside the drainage reën.</i> |
| Site History | <i>The site in 1883 comprised field land alongside the River Usk. By 1937 a collection of small buildings had been erected alongside the river part way up the site, accessed via a trackway along the river's edge. Between 1937 and 1955 these buildings were replaced by a single house and an adjacent rectangular building of unspecified use, which were later demolished, and the trackway was constructed upon a raised embankment, as is seen presently.</i> |
| Ground Conditions | <i>The ground conditions were found to comprise made ground of variable granular and clay deposits with waste content including brick and concrete to a confirmed depth of between 5.2m and 5.4m depth, underlain by soft to very soft alluvial clay with bands of peat to depths of between 15.9m and 16.3m. Below the clay gravel is present to 16.8m/19.0m, being between 0.2m and 2.7m in thickness. St Maughans' Formation mudstone or sandstone bedrock underlies the superficial cover.</i> |
| Radon | <i>Basic radon protection is required for new development.</i> |
| Ground Gas/Landfill Gas | <i>In-situ gas monitoring has confirmed that gas protection measures will be required for the new apartments.</i> |
| Laboratory Chemical Testing and Proposed Remediation | <p><i>Laboratory analysis of site soils was undertaken. Lead was found to be present at a concentration of 470mg/kg in made ground in TP2 (0.6m), exceeding the residential threshold level of 200mg/kg. Chrysotile asbestos fibres were identified in made ground in TP06 (0.4m). Fragments of asbestos containing material were also visually identified in this location.</i></p> <p><i>Upon development the area of TP2 and TP6 will be capped with the new road, which will act as a physical barrier between the made ground and human receptors. No remedial measures are required for the any garden or landscaped areas adjacent to the new Phase 1 apartments.</i></p> <p><i>Any imported soils should be validated as clean and suitable for use in accordance with 'Requirements for the Chemical testing of Imported Soils for Various End Uses and Validation Cover Systems'.</i></p> <p><i>For proposed new supply water pipes, the UK Water Industry Research publication 'Guidance for the Selection of Water Supply Pipes to be used in Brownfield Sites (Report 10/WM/03/21)' should be consulted.</i></p> |
| Foundation Solution | <p><i>Due to the presence of made ground and soft alluvial clays beneath the site traditional shallow foundations are not recommended. Such foundations will lead to high total and differential settlements.</i></p> <p><i>A piled foundation is advised for the proposed apartment blocks. Precast concrete driven piles founded within the underlying weathered red mudstone and/or sandstone is recommended. For a 275mm square precast concrete pile driven to an appropriate set within the underlying competent mudstone a safe working load of typically 500kN should be achieved. Based upon the site investigation data, pile lengths should vary between 20m and 22m beneath current ground levels.</i></p> <p><i>Measurements should be kept on pile vibrations during driving. Measures should also be taken to dampen such vibrations. If, however, vibrations exceed permissible values then consideration should be given to using a contiguous flight auger (cfa)/bored pile solution.</i></p> <p><i>Floor slabs should be designed as suspended.</i></p> |

TABLE OF CONTENTS

SECTION 1 Introduction and Proposed Development

- 1.1 Introduction
- 1.2 Limitations and Exceptions of Investigation

SECTION 2 Review of Existing Data

- 2.1 Physical Setting and Current Site Use
- 2.2 History
- 2.3 Geological Setting
 - 2.3.1 Geology
 - 2.3.2 Coal Mining
 - 2.3.3 Radon
- 2.4 Hydrogeology and Hydrology
- 2.5 Environmental Setting
 - 2.5.1 Industrial Operator Scores
 - 2.5.2 Industrial Pollution
 - 2.5.3 Pollution Incidents
 - 2.5.4 Landfills
 - 2.5.5 Groundwater Source Protection Zones

SECTION 3 Preliminary Human Health and Environmental Risk Assessment

- 3.1 General
- 3.2 Preliminary Site Conceptual Model
- 3.3 Potential Sources of Contamination and Gas
- 3.4 Potential Receptors and Pollution Pathways

SECTION 4 Field Investigation

- 4.1 Site Works
- 4.2 Ground Conditions
- 4.3 Water Strikes
- 4.4 Stability and Obstructions
- 4.5 Soil Laboratory Chemical Testing
 - 4.5.1 Exploratory Strategy and Sampling Regime
 - 4.5.2 Laboratory Analysis
 - 4.5.2.1 Soils
 - 4.5.2.2 Leachate

SECTION 5 Soil and Leachate Analytical Results

- 5.1 Soil Assessment Methodology
- 5.2 Soil Test Results
- 5.3 Leachate Assessment Methodology
- 5.4 Leachate Test Results

Section 6 Gas Monitoring

TABLE OF CONTENTS (Continued)**Section 7 Quantitative Risk Assessment**

- 7.1 Contaminants of Concern
 - 7.1.1 Contaminants of Concern in Soil
 - 7.1.2 Leachable Contaminants of Concern
- 7.2 Potential Receptors and Pathways
 - 7.2.1 Human Receptors
 - 7.2.2 Aquatic Environment
- 7.3 Mitigation and Remedial Measures
 - 7.3.1 Human Health
 - 7.3.2 Aquatic Environment

Section 8 Engineering Recommendations

- 8.1 Preparation of Site
- 8.2 Foundation and Floor Slab Solution
- 8.3 Excavations and Formations
- 8.4 Protection of Buried Concrete
- 8.5 Access Roads and Car Parking Areas

Tables

- Table 3.1 Preliminary Human Health Risk Assessment
- Table 3.2 Preliminary Environmental Risk Assessment
- Table 4.1 Summary of Ground
- Table 4.2 Sample Locations and Depths
- Table 5.1 Summary of Soil Chemical Test Results - Standard Suite
- Table 5.2 Summary of Soil Chemical Test Results - Speciated PAH
- Table 5.3 Summary of Soil Chemical Test Results - Asbestos
- Table 5.4 Summary of Leachate Test Results

Figures

- Figure 2.1 Site Location - OS Map 152 Newport and Pontypool

Annexes

- Annex A Landmark Historical Maps
- Annex B Radon Report
- Annex C Risk Assessment Definitions
- Annex D Trial Pit Logs
- Annex E Borehole Logs
- Annex F Laboratory Soil and Leachate Chemical Test Results
- Annex G Gas Monitoring Results

Drawings

- Drawing 01 Site Layout

SECTION 1 Introduction and Proposed Development

1.1 Introduction

Keepmoat is proposing the residential development of an area of land off Herbert Street, Newport.

This development is to be constructed in four phases. This report applies to the Phase 1 development only (henceforth referred to as 'the site'). Phase 1 extends northwards from Courtney Street along the River Usk and includes an area alongside the drainage reën and a new road on the main body of the site. Three apartment blocks are to be constructed on the Phase 1 site.

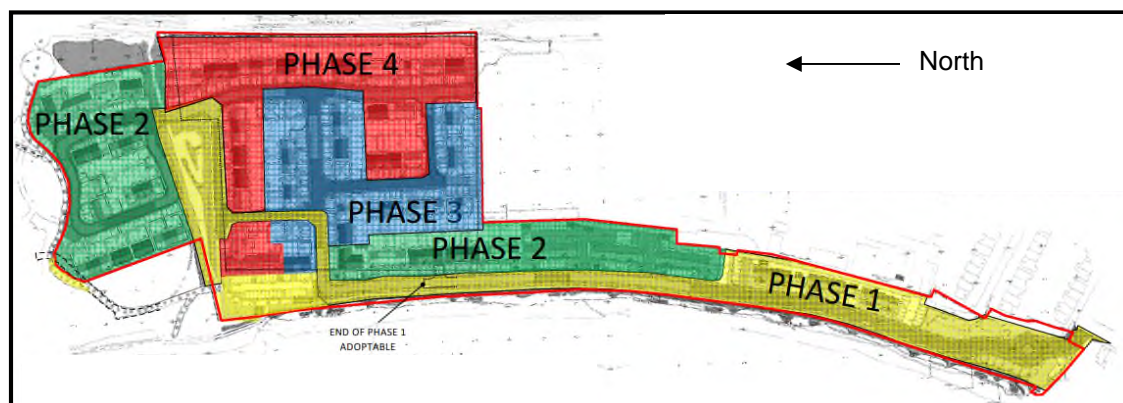

Figure 1.1: Phase 1 Layout

The section of new road and area alongside the drainage reën on the main body of the site was previously included in an investigation by Terra Firma in 2013, as reported in Geotechnical and Geo-environmental Report No. 12032. This area has been excluded from this report as ground conditions have been proved and all soil chemical data has already been assessed and approved.

Terra Firma (Wales) Limited has been commissioned to undertake a geo-environmental assessment and geotechnical investigation of the site.

The main objectives of the geoenvironmental assessment programme were to:

- Investigate the potential environmental liabilities at the site associated with any soil contamination
- Provide a summary of the environmental conditions at the site, together with any necessary further intrusive works and / or remediation works to render the site fit for its intended use

The main objectives of the geotechnical site investigation were to:

- Determine the type, strength and bearing characteristics of the shallow superficial and underlying solid geology
- Provide engineering foundation and floor slab recommendations for the development
- Provide recommendations with regard to any other geotechnical aspects pertaining to the development

In order to achieve the above objectives, Terra Firma (Wales) Limited carried out an assessment programme including a review of existing data, followed by a field investigation to collect geotechnical and environmental data from selected locations.

1.2 Limitations and Exceptions of Investigation

Keepmoat has requested that a Geoenvironmental Site Assessment (GSA) and Geotechnical Investigation (GI) be performed in order to determine if contamination is present beneath the site and to determine an appropriate foundation and floor slab solution for the proposed development.

The GSA and GI were conducted and this report has been prepared for the sole internal reliance of Keepmoat and its design and construction team. This report shall not be relied upon or transferred to any other parties without the express written authorisation of Terra Firma (Wales) Limited. If an unauthorised third party comes into possession of this report they rely on it at their peril and the authors owe them no duty of care and skill. The report represents the findings and opinions of experienced geoenvironmental and geotechnical consultants. Terra Firma (Wales) Limited does not provide legal advice and the advice of lawyers may be required.

The subsurface geological profiles, any contamination and other plots are generalised by necessity and have been based on the information found at the locations of the exploratory holes and depths sampled and tested.

SECTION 2 Review of Existing Data

2.1 Physical Setting and Current Site Use

The site is situated along the River Usk, Newport, and is centred on an approximate National Grid Reference of 331621 189115. It occupies a plan area of approximately 1.5 hectares.

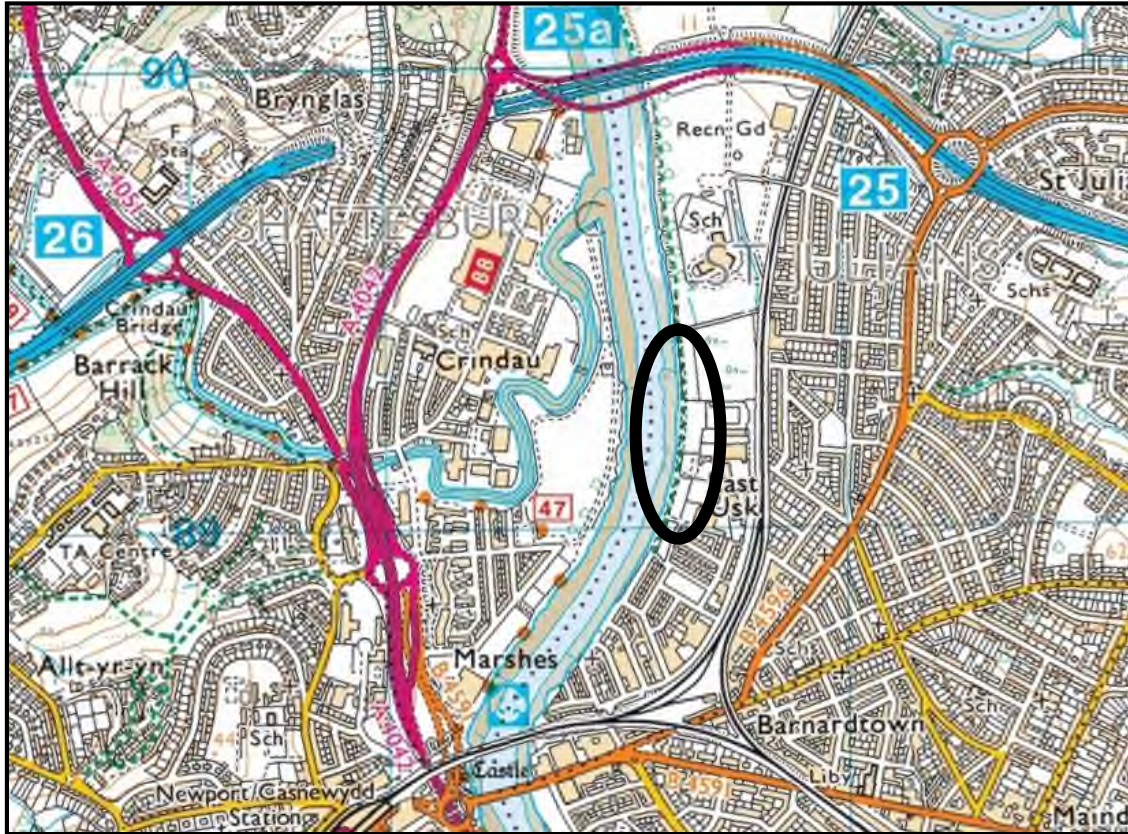

Figure 2.1: Site Location – OS Map 152 Newport and Pontypool

The site primarily comprises rough grassland along the River Usk intersected by a tarmac footpath. The footpath is frequented by dog walkers and those accessing the river.

The area of Phase 1 that extends on to the main body of the Herbert Road development site will comprise a road and a section alongside the drainage reën.

2.2 Site History

The history of the site has been traced using historical Ordnance Survey maps from Landmark Information Group. The maps may be found in **Annex A**. Please note that the boundary of Phase 1 is not specified on these plans, and the southern extent of the site denoted is incorrect. The Phase 1 site extends further south than shown. A summary of the history of the site is given below. Distances, where quoted, are approximate.

The site in 1883 is seen to comprise field land alongside the River Usk, intersected by east-west aligned drainage reens. A brick works (Brick Field) occupies land to the south, which by 1902 includes a large excavated area directly adjacent to the site's southern tip. This is likely to have been used to access clay for the brick works, known in 1902 as Newport Patent Brick Works. By 1920 the brick works is no longer present and housing is seen to have extended up to the far southern site boundary along Collier Street. Courtney Street also exists at this time across the former excavated depression, although no terraced housing has yet been established. By 1937 the Courtney Street terraces have been built and a collection of small buildings have been erected alongside the river part way up the site, accessed via a trackway along the river's edge. Their use is not documented. Between 1937 and 1955 the track along the river has been constructed upon a raised embankment, as is seen presently. The collection of small buildings has been removed and a single property, Glen Usk, takes their place along with a rectangular building of unspecified use. Both of these structures situate in the Phase 2 site area but may slightly overlap on to the Phase 1 site. A field now appointed as allotment gardens overlaps on the southern section of site. A clothing factory has been established on the main part of the Herbert Road development site (Phases 3 & 4). Very little change has occurred to the site since 1955, although the allotment gardens and Glen Usk were absent by 1978.

2.3 Geological Setting

2.3.1 Geology

The 1:50,000 scale geological map of the area (Sheet 249) was consulted. This shows the site to be underlain by rocks of the by the St Maughan's Formation, belonging to the Devonian Period. These rocks comprise interbedded argillaceous rocks with subordinated sandstone.

The solid geology is shown to be overlain by estuarine alluvium.

Made ground is anticipated to be present across the section of site alongside the River Usk in connection with raising of the footpath route between 1937 and 1955.

2.3.2 Coal Mining

The site lies outside the South Wales Coalfield. The site will not be affected by past mining.

2.3.3 Radon

A radon report acquired from the British geological Survey (**Annex B**) details that basic radon protection will be required for new buildings on site.

2.4 Hydrogeology and Hydrology

The bedrock beneath the site is detailed to be a Secondary A aquifer. These aquifers are permeable layers capable of supporting water supplies at a local rather than strategic scale, and in some cases forming an important source of base flow to rivers. These are generally aquifers formerly classified as minor aquifers.

The estuarine alluvium is classified as unproductive strata.

Any surface or shallow groundwater flows along the river will either be towards the River Usk, adjacent land to the east, or the main body of the Herbert Road development site. Part of the Phase 1 site lies directly alongside a drainage reed.

Deeper groundwater flow within the underlying bedrock will be controlled by the strata dip and any fractures or bedding planes within the rock units.

2.5 Environmental Setting

Relevant data sourced from the Environment Agency online 'What's in Your Back Yard' database in 2013 is summarised in the following sections.

2.5.1 Industrial Operator Scores

There are no sites within a 1km radius of the site where pollution is regulated.

2.5.2 Industrial Pollution

There are no industrial pollution scores within a 1km radius of the site where pollution is regulated.

2.5.3 Pollution Incidents

There is one pollution incident within close proximity of the site. The incident took place in February 2004 approximately 200 metres south of the site. The incident caused a significant impact to land and involved 'specific waste materials'.

2.5.4 Landfills

One historical landfill facilities is located within influencing distance of the part of the site to be residentially developed.

Shaftsbury Park historic landfill is located approximately 120 metres west of the site. No information is provided regarding the date at which the landfill was active. Shaftsbury Park received industrial and household waste.

2.5.5 Groundwater Source Protection Zones

The site does not locate within a groundwater protection zone.

SECTION 3 Preliminary Human Health and Environmental Risk Assessment

3.1 General

The contaminated land regime is set out in Part IIA of the Environmental Protection Act (EPA) 1990 and was introduced on the 1st April 2000 in England and 1st July 2001 in Wales. A similar regime was introduced in Scotland on 14th July 2000. Part IIA was introduced to achieve two aims:

- (1) The identification of contaminated land
- (2) The remediation of contaminated land that poses an unacceptable risk to human health and/or the environment

Under Part IIA the statutory definition of 'contaminated land' is: any land which appears to the local authority in whose area it is situated, to be in such a condition, by reason of substances in, on, or under the land, that:

- (a) Significant harm is being caused or there is a significant possibility of such harm being caused; or
- (b) Pollution of controlled waters is being, or is likely to be, caused."

For land to be classified as 'Contaminated Land' there must be a 'pollutant linkage'.

For our definitions of pollution linkage and how we define risk please refer to **Annex C** which includes our classifications of consequence and probability and risk assessment matrix.

3.2 Preliminary Site Conceptual Model

The preceding sections enable a preliminary conceptual model of the site to be drawn up, to illustrate the likely ground conditions beneath the site together with a preliminary assessment of the nature of any underlying aquifers and groundwater movement. The preliminary site conceptual model is used as a model for the design and implementation of the site investigation, whereby areas of potential contamination can be targeted as well as investigating the site as a whole.

3.3 Potential Sources of Contamination and Gas

The potential contamination beneath the site, whether in the matrix of soil or any groundwater will be related to the sites site past use and the history of the surrounding area.

Fill is expected to be present for the majority of the site, alongside the River Usk, which appears to have been historically raised. The source or type of fill is unknown. This could comprise waste materials from local industry. Any fill is considered to be a potential source of contamination.

Previous exploratory holes excavated on the section of Phase 1 that extends on to the main part of the Herbert Road development site did not identify made ground. However, current filling has raised levels with imported material, but all imported soils have been pre-tested and approved for use by the NRW and Newport City Council.

Any fill and underlying bands of peat known to exist within the alluvium are known to present a risk from ground gas.

3.4 Potential Receptors and Pollution Pathways

There are both human and hydrological receptors to be considered should any contamination be detected on site.

Construction workers will be excavating in soils and will be exposed via dermal contact with soils and dust, ingestion of soil dust and inhalation of soil dust or vapours. Workers may also be exposed to asbestos fibres, if present in fill soils.

A residential end use is proposed on part of the Phase 1 site, comprising three apartment blocks. Once developed, future site residents will potentially be at risk from any contamination from the same pathways as well as through intake of potable water and inhalation of ground gas.

Future site residents are at risk from ground gas. The risk from landfill gas is negligible given that the historical landfill identified within influencing distance of the site lies on the opposing side of the River Usk.

Any future maintenance contractors could be at risk from dermal contact with soils and dust, ingestion of soil dust and inhalation of soil dust/asbestos fibres/vapours.

Passers-by and neighbouring site users are similarly at risk from site soils via soil dust and asbestos fibre inhalation.

If any contamination is identified this may be leachable, enabling it to mobilise through perched groundwater within site soils and impact the river or deeper groundwater.

A qualitative preliminary Human Health and Environmental Risk Assessment summarises the above and is detailed in the **Tables 3.1 and 3.2** on the following pages.

Table 3.1 - Qualitative Preliminary Human Health Risk Assessment

| Potential Source | Pathway | Receptor During Construction | Level of Risk | Receptor Post Construction | Level of Risk |
|------------------|--|--|---------------|---|---|
| Made ground | Ingestion, inhalation and dermal contact with soil and soil dust | Construction Workers | Medium Risk | Future residents Maintenance Contractors | Medium Risk |
| Made ground | Inhalation of soil dust | Neighbouring site users and passers-by | Low Risk | Neighbouring site users and passers-by | Low Risk |
| Made ground | Inhalation of asbestos fibres | Construction Workers Neighbouring site users and passers-by | Medium Risk | Future residents Maintenance Contractors Neighbouring site users and passers-by | Medium Risk |
| Made ground | Inhalation of Vapours | Construction Workers | Low Risk | Future residents Maintenance Contractors | Low Risk |
| Radon Gas | Inhalation <i>Accumulation of gas indoors in confined spaces- asphyxiation and explosion</i> | N/A | N/A | Future residents | Unacceptable Risk <i>BGS confirm BASIC Radon Protection required for new buildings</i> |
| Landfill Gas | Inhalation <i>Accumulation of gas indoors in confined spaces- asphyxiation and explosion</i> | N/A | N/A | Future residents | No Risk <i>Landfill lies on opposing side of River Usk</i> |
| Ground Gas | Inhalation <i>Accumulation of gas indoors in confined spaces- asphyxiation and explosion</i> | N/A | N/A | Future residents | High Risk <i>Potential gas where made ground and peat present.</i> |
| Made Ground | Ingestion of potable water <i>Absorption of contamination from made ground into potable water pipes</i> | N/A | N/A | Future Residents | Medium Risk |

Table 3.2 – Qualitative Preliminary Environmental Risk Assessment

| Potential Source | Pathway | Receptor During Construction | Level of Risk | Receptor Post Construction | Level of Risk |
|---------------------------------|---|--|---|--|--|
| Surface Water | Run-off | Site and Adjacent Sites Shallow/Perched Groundwater | Low | Site and Adjacent Sites Shallow/Perched Groundwater | Low |
| Accidental spillage | Run-off , digging foundations, moving contaminated soil, drainage misconnections, discharges to local surface waters or the ground, construction materials and/or exposed ground, wheel washings, oil or chemical spills | Site and Adjacent Sites | Low <i>On site procedures will ensure that all efforts are made to prevent accidental spillage</i> | N/A | N/A |
| Made Ground | Leaching of contamination | Shallow/Perched Groundwater | Medium Risk | Shallow/Perched Groundwater | Medium Risk |
| Contaminated Groundwater | Direct migration and Perched Groundwater migration | Secondary A Aquifer | Low Risk <i>Superficial alluvium acts to confine perched groundwater above underlying bedrock</i> | Secondary A Aquifer | Low Risk <i>Superficial alluvium acts to confine perched groundwater above underlying bedrock</i> |
| Contaminated Groundwater | Groundwater Migration | River Usk | Medium Risk | River Usk | Medium Risk |

SECTION 4 Field Investigation

4.1 Site Works

A geo-technical and geo-environmental site investigation was carried out during January and February 2017. This comprised twelve machine excavated trial holes and four cable percussive boreholes.

The trial pits were excavated by JCB.

The boreholes were sunk using a Shell and Auger drilling rig. Standard penetration tests were undertaken at regular depths in the boreholes. The boreholes were terminated within the Mercia Mudstone after one hour of chiselling.

The fieldworks were supervised by Terra Firma (Wales) Limited and the trial pits and boreholes were logged to the requirements of BS5930:2015.

The trial pit logs may be found in **Annex D** and the borehole logs are available in **Annex E**. Exploratory locations are given on **Drawing 01**.

4.2 Ground Conditions

Trial pits excavated along the length of the river encountered made ground to the maximum excavation depth, which ranged from 1.1m and 3.0m. This generally comprises sand and gravel or gravelly clay deposits with variable competency and content of waste materials, particularly brick and concrete. Fragments of corrugated cement sheeting containing asbestos were also noted in made ground in TP6.

A summary of the ground conditions identified in the trial pits and boreholes beneath the area of the proposed apartment blocks is given in **Table 4.1**.

| Table 4.1 Summary of Ground Conditions Area of Proposed Apartment Blocks | | |
|---|---------------|---|
| Depth (m) | Thickness (m) | Stratum |
| 0.0 - 5.2/5.4 | 5.2/5.4 | MADE GROUND: Soft to firm grey CLAY / Loose red and grey very clayey SAND and GRAVEL and COBBLE with brick / Medium dense to dense GRAVEL of mudstone / Very loose ASH |
| 5.2/5.4 - 15.9/16.3 | 10.6/11.1 | Soft to very soft grey silty CLAY ALLUVIUM with PEAT and PEATY bands |
| 15.9/16.3 - 16.8/19.0 | 0.2/1.7 | Dense red GRAVEL and COBBLE of mudstone |
| >16.8/19.0 | - | Weathered red MUDSTONE or SANDSTONE (St Maughan's Formation) |

The depth to the top of the mudstone/sandstone bedrock generally increases towards the south.

4.3 Water Strikes

Groundwater inflow was not encountered in the trial pits.

Water strikes were made in the boreholes, at 3.0m in BH1, 16.3m in BH2, 3.2m and 16.3m in BH3 and at 3.0m in BH4.

4.4 Stability and Obstructions

Trial holes were unstable in places where granular made ground was noted.

4.5 Soil Laboratory Chemical Testing

4.5.1 Exploratory Strategy and Sampling Regime

During the intrusive investigation, small disturbed soil samples were collected. The sampling regime was conducted in accordance with BS5930: 1999 in order to satisfy the following criteria:

- Identify and confirm suspected sources of contamination
- Determine type and concentration of contamination
- Determine lateral and vertical spread of contaminants
- Ensure representation of the entire site
- Provide sufficient data to determine suitable remedial measures if necessary

The sample locations and depths are listed in the following table.

| Table 4.2 Sample Locations and Depths | | |
|--|------------------|--|
| Sample | Depth (m) | MCerts Sample Matrix Description |
| TP1 | 0.3 | Brown gravelly, sandy CLAY |
| TP2 | 0.6 | Dark brown gravelly, sandy CLAY (Made ground - brick) |
| TP3 | 0.2 | Brown gravelly, sandy CLAY including odd rootlets |
| TP4 | 0.5 | Brown gravelly, sandy CLAY |
| TP5 | 0.3 | Dark brown gravelly, sandy CLAY (Made ground - brick, glass) |
| TP6 | 0.4 | Brown gravelly, sandy CLAY |
| TP7 | 0.2 | Brown gravelly, sandy CLAY including numerous rootlets |
| TP8 | 0.6 | Dark brown gravelly, sandy CLAY |
| TP9 | 0.4 | Brown gravelly, sandy CLAY (Made ground - brick) |
| TP10 | 0.2 | Brown gravelly, sandy CLAY including odd rootlets |
| TP11 | 0.5 | Dark grey gravelly, sandy CLAY including odd rootlets (Possible made ground - brick) |
| TP12 | 0.3 | Brown gravelly, sandy CLAY (Possible made ground - brick) |

4.5.2 Laboratory Analysis

The soil samples taken were despatched to the laboratories of Derwentside Environmental Testing Services Limited.

4.5.2.1 Soils

The following chemical tests were undertaken:

Metals and Metalloids

Lead
Arsenic
Mercury
Chromium
Copper
Nickel
Zinc

In-Organics

Cyanide
Sulphate

Others

pH (acidity)
Organic Matter
Asbestos

Organic Chemicals

Phenol
Polycyclic Aromatic Hydrocarbons (PAHs)

The laboratory soil chemical test results are presented in **Annex F**.

4.5.2.2 Leachate

The following leachate tests were undertaken on one or more samples:

Lead
Sulphate

The laboratory soil chemical test results are presented in **Annex F**.

SECTION 5 Soil and Leachate Analytical Results

5.1 Soil Assessment Methodology

Comparison of the analytical results has been made with Soil Guideline Values (SGVs) for a residential scenario (including plant uptake), sourced from The Environment Agency Contaminated Land Exposure Assessment (CLEA). Where SGV values are not available reference has been made to the 2015 residential (including plant uptake) Suitable 4 Use Levels (S4ULs) provided by Land Quality Management Limited and the Chartered Institute of Environmental Health (CIEH) or Category 4 Screening Levels (C4SLs).

Sulphate results have been compared to British Research Establishment (BRE) guidelines as sulphate levels need only be considered for buried concrete risk assessment only, not human health related.

5.2 Soil Test Results

A summary of the chemical test results which include the regulatory soil guideline values used in the Tier 1 assessment are given in **Tables 5.1 to 5.3**.

| Table 5.1 Summary of Soil Chemical Test Results Standard Suite | | | | | |
|---|-----------------|--------|--|---------|-----------------------|
| Substance | SGV/GAC (mg/kg) | Source | Measured Concentrations of Tested Substances (mg/kg) | | Number of Exceedences |
| | | | Minimum | Maximum | |
| Arsenic | 32 | CLEA | 9.6 | 32 | 0 |
| Cadmium | 10 | CLEA | 0.1 | 3.2 | 0 |
| Chromium III | 910 | CIEH | 8.4 | 40 | 0 |
| Chromium VI | 6 | CIEH | <1.0 | <1.0 | 0 |
| Copper | 2400 | CIEH | 22 | 110 | 0 |
| Lead | 200 | C4SL | 27 | 470 | 1 |
| Mercury | 170 | CLEA | 0.05 | 0.66 | 0 |
| Nickel | 180 | CIEH | 5.6 | 39 | 0 |
| Selenium | 350 | CLEA | <0.5 | 0.8 | 0 |
| Zinc | 3700 | CIEH | 46 | 250 | 0 |
| Cyanide | 8 | CLEA | <0.1 | 0.5 | 0 |
| Phenols | 420 | CLEA | <0.3 | 0.8 | 0 |
| Sulphate | 2400 | BRE | 400 | 2700 | 1 |
| Organic Matter | - | - | 1.0 | 6.8 | - |
| pH | - | - | 8.2 | 10.2 | - |
| Total PAH | - | - | 1.3 | 7.6 | See Table 5.2 |

Notes:

- no available guideline

5.2 Soil Test Results (Continued)

All samples were tested for speciated PAH testing.

| Table 5.2 Summary of Soil Chemical Test Results Speciated PAH | | | | | |
|--|----------------|--------|--|---------|--------------------------|
| Substance | GAC (mg/kg) | Source | Measured Concentrations of Tested Substances (mg/kg) | | Number of Exceedences |
| | | | Minimum | Maximum | |
| Naphthalene | 2.3 | CIEH | <0.03 | 0.06 | 0 |
| Acenaphthylene | 170 | CIEH | <0.03 | 0.04 | 0 |
| Acenaphthene | 210 | CIEH | <0.03 | 0.13 | 0 |
| Fluorene | 170 | CIEH | <0.03 | 0.01 | 0 |
| Phenanthrene | 95 | CIEH | <0.03 | 0.7 | 0 |
| Anthracene | 2400 | CIEH | <0.03 | 0.16 | 0 |
| Fluoranthene | 280 | CIEH | <0.03 | 2.9 | 0 |
| Pyrene | 620 | CIEH | <0.03 | 1.8 | 0 |
| Benzo(a)anthracene | 7.2 | CIEH | <0.03 | 0.68 | 0 |
| Chrysene | 15 | CIEH | <0.03 | 0.55 | 0 |
| Benzo(b)fluoranthene | 2.6 | CIEH | <0.03 | 0.79 | 0 |
| Benzo(k)fluoranthene | 77 | CIEH | <0.03 | 0.26 | 0 |
| Benzo(a)pyrene | 2.2 | CIEH | <0.03 | 0.56 | 0 |
| Indeno(123cd)pyrene | 27 | CIEH | <0.03 | 0.3 | 0 |
| Dibenzo(ah)anthracene | 0.24 | CIEH | <0.03 | 0.09 | 0 |
| Benzo(ghi)perylene | 320 | CIEH | <0.03 | 0.33 | 0 |

Notes:

- Thresholds based on 1.0% SOM

Asbestos testing was undertaken on samples of made ground. **Table 5.3** below summarises the findings:

| Table 5.3 Summary of Soil Test Results Asbestos | | |
|--|-----------|-----------------------------------|
| Location | Depth (m) | Result |
| TP1 | 0.3 | No Asbestos Detected |
| TP2 | 0.6 | |
| TP3 | 0.2 | |
| TP4 | 0.5 | |
| TP5 | 0.3 | |
| TP6 | 0.4 | Small bundle of chrysotile fibres |
| TP7 | 0.2 | No Asbestos Detected |
| TP8 | 0.6 | |
| TP9 | 0.4 | |
| TP10 | 0.2 | |
| TP11 | 0.5 | |
| TP12 | 0.3 | |

5.3 Leachate Assessment Methodology

Substances found to be present above their respective soil guideline value have been subject to leachate analysis.

Leachate test results have been compared to thresholds for inland freshwater environments (annual average) provided by the 2009 and 2015 UK Water Framework Directive (WFD).

Sulphate has been compared to BRE criteria for assessment in relation to construction concrete (see **Section 8.5**).

5.4 Leachate Test Results

The leachate test results are detailed in **Table 5.4**.

| Table 5.4 Summary of Leachate Test Results | | | | |
|---|------------------|--------|---|-----------------------|
| Substance | Threshold (ug/l) | Source | Measured Concentrations of Tested Substances (ug/l) | Number of Exceedences |
| | | | TP2 (0.3m) | |
| Lead | 1.2 | WFD | 0.27 | 0 |

SECTION 6 Gas Monitoring

Three gas wells were installed to assess if there are any risks from ground gas/landfill gas on site, in BH1, BH2 and BH4.

One round of gas monitoring has been carried out to date.

Methane concentrations were found to be undetectable in all boreholes.

Carbon dioxide levels varied between being 0.4% to 6.7% V/V.

Oxygen concentrations varied between 9.6% and 19.9% V/V.

The gas flow rate from the boreholes was also assessed. No flow was recorded.

Based on the gas monitor flow rate detection limit of 0.1l/hr and the highest recorded carbon dioxide concentration of 6.7%, a gas screening value of 0.0067l/hr is calculated, as follows:

$$(6.7/100) \times 0.1 = 0.0067\text{l/hr}$$

When this result is compared with Table 8.5 of CIRIA report C665, the site is classified as 'gas characteristic situation 1'.

No gas protection measures are required for 'gas characteristic situation 1' sites.

However, given that the maximum carbon dioxide level exceeds 5% it is considered that gas protection should be incorporated into the development in accordance with '**gas characteristic situation 2**'.

Table 8.6 of the above publication confirms that for residential gas characteristic 2 sites, the following precautions are required:

- For a reinforced concrete cast in-situ floor slab (suspended, non-suspended or raft) - at least 1200g DPM and underfloor venting. All joints taped and sealed.
- For a beam and block or pre-cast concrete floor - 2000g DPM/reinforced gas membrane and underfloor venting.
- All joints taped and sealed.

Once the full 6 monitoring visits have been made, this classification will be reviewed and if necessary amended.

The gas monitoring results are presented in **Annex G**.

SECTION 7 Quantitative Risk Assessment

7.1 Contaminants of Concern

7.1.1 Contaminants of Concern in Soil

Contaminants of concern are those that were found to exceed their residential threshold level.

Only lead and asbestos were identified as contaminants of concern. Lead was found to be present at a concentration of 470mg/kg in made ground in TP2 (0.6m), exceeding the residential threshold level of 200mg/kg.

Chrysotile asbestos fibres were identified in made ground in TP06 (0.4m). Fragments of asbestos containing material were also visually identified in this location.

Sulphate was exceeded in one sample when compared to BRE concrete DS1 thresholds. This does not present a risk to human health.

7.1.2 Leachable Contaminants of Concern

No leachable contaminants of concern were identified.

7.2 Potential Receptors and Pathways

7.2.1 Human Receptors

Contamination has been identified in made ground on site in the form of lead in TP2 and asbestos in TP6.

Receptors are considered to be at risk from dermal contact with soils/soil dust, ingestion of soil/soil dust and inhalation of soil dust and asbestos fibres.

Radon presents a possible risk to human health.

In-situ gas monitoring has identified from carbon dioxide.

7.2.2 Aquatic Environment

The aquatic environment is not considered to be at risk.

7.3 Mitigation and Remedial Measures

7.3.1 Human Health

As good practice, construction workers should adhere to good site management, COSHH, good standards of hygiene and appropriate health & safety on site, with personal protection equipment (PPE) and dust suppression where appropriate. This should include protection from asbestos fibres if working in made ground identified in TP6.

Upon development the area of TP2 and TP6 will be capped with the new road, which will act as a physical barrier between the made ground and human receptors.

No remedial measures are required for the any garden or landscaped areas adjacent to the new Phase 1 apartments.

7.3.1 Human Health (Continued)

Any imported soils should be validated as clean and suitable for use in accordance with 'Requirements for the Chemical testing of Imported Soils for Various End Uses and Validation Cover Systems'.

For proposed new supply water pipes, the UK Water Industry Research publication 'Guidance for the Selection of Water Supply Pipes to be used in Brownfield Sites (Report 10/WM/03/21)' should be consulted.

Gas protection measures should be installed as described in **Section 6**.

In accordance with EC Regulation 1272/2008 and Environment Agency Guidance WM3 soils destined for off-site disposal should be classified on the basis of their hazard phrases prior to disposal. Soils are classified as a mirror entry waste and should be classified on the basis of their specific chemical properties. Terra Firma (Wales) Ltd offer this service if required.

7.3.2 Aquatic Environment

During the construction period, there is a risk to the environment/adjacent sites from de-watering, digging foundations, moving contaminated soil, drainage misconnections, discharges to local surface waters or the ground, runoff from construction materials and/or exposed ground, wheel washings and oil or chemical spills.

The risk is considered to be negligible as any adverse effects will be easily preventable by due diligence to good construction practise and housekeeping in preventing surface runoff and the spillage of materials.

The basic measures that should be taken are as follows:

- Prepare a drainage plan and mark the manholes to prevent pollutants accidentally reaching the surface water sewers;
- Carry out any activities that could cause pollution in a designated, bunded area, away from rivers or boreholes. Where possible it should drain to the foul sewer;
- Use settlement ponds to remove silty water;
- Store all oils and chemicals in a fully bunded area to prevent leaks or spills;
- Get advice on whether you need an environmental permit and apply in good time

SECTION 8 Engineering Recommendations

8.1 Preparation of Site

All areas of hardstanding should also be excavated out and removed.

All vegetation including all roots should be stripped and removed from beneath the proposed buildings and areas of hard standing.

Contingencies should be made for the protection/diversion any underground/overhead services present beneath the site brought about as a result of the proposed works.

Allowances should be made for the excavation of any soft spots/areas and their replacement with well compacted imported granular materials.

Any reduced levels should be brought up to the required levels with suitable inert mainly granular materials. Department of Transport (DoT) type 2 sub base or similar should be used and should be compacted in layers to the requirements of the Specification for Highway works.

In accordance with EC Regulation 1272/2008 and Environment Agency Guidance WM3 soils and other materials destined for off-site disposal should be classified on the basis of their hazard phrases prior to disposal. Soils are classified as a mirror entry waste and should be classified on the basis of their specific chemical properties. Terra Firma (Wales) Ltd offer this service if required.

8.2 Foundation and Floor Slab Solution

Due to the presence of made ground and soft alluvial clays beneath the site traditional shallow foundations are not recommended. Such foundations will lead to high total and differential settlements.

A piled foundation is advised for the proposed apartment blocks. Precast concrete driven piles founded within the underlying weathered red mudstone and/or sandstone is recommended.

For a 275mm square precast concrete pile driven to an appropriate set within the underlying competent mudstone a safe working load of typically 500kN should be achieved. Based upon the site investigation data, pile lengths should vary between 20m and 22m beneath current ground levels.

The estimated working loads, pile type and lengths should be confirmed by a specialist piling contractor. It may be prudent to test drive piles at select locations.

For the quoted pile size, founded within the competent bedrock, total settlements should not exceed 10mm with differential movements between adjacent piles being less than half this value.

Allowances should be made for re-driving piles should buried obstructions be encountered.

Floor slabs should be designed as suspended.

Measurements should be kept on pile vibrations during driving. Measures should also be taken to dampen such vibrations. If, however, vibrations exceed permissible values then consideration should be given to using a contiguous flight auger (cfa)/bored pile solution.

8.2 Foundation and Floor Slab Solution (Continued)

All foundation formations should be inspected by a suitably qualified Engineer before being concreted.

8.3 Excavations and Formations

Shallow excavations will be possible with normal soil excavating machinery.

Shallow perched water flows are not expected. Any water inflows together with rainwater infiltration should be dealt with by conventional pumping techniques.

The sides of any excavations deeper than 1.0m, or shallower if unstable, should be supported by planking and strutting or other proprietary means.

The sub-formations/formations are likely to be susceptible to loosening, softening and deterioration by exposure to weather (rain, frost and drying conditions), the action of water (flood water or removal of groundwater) and site traffic.

Formations should never be left unprotected and continuously exposed to rain causing degradation, or left exposed/uncovered overnight, unless permitted by a qualified engineer.

Construction plant and other vehicular traffic should not be operated on unprotected formations.

As a minimum the formation/excavation surfaces must be protected by blinding concrete immediately after exposure.

Allowances should be made for the removal of soft spots/areas and their replacement with well compacted granular materials.

Allowances should also be made for special precautions to prevent formation deterioration in addition to the above.

8.4 Protection of Buried Concrete

Levels of total sulphate within the in-situ materials measured between 400mg/kg to 2700mg/kg and the pH varied between 8.2 and 10.2.

As a whole all buried concrete should most likely as a minimum conform to Class AC-1 (Table C2 of BRE Digest 1:2005). However, should any concrete structures be placed in the area of TP11 then consideration should be given to Class AC-2.

8.5 Access Roads and Car Parking Areas

For car parking and road areas, formations within the in-situ soils a CBR value of 1-3% may be used for design purposes.

Allowances should be made for the removal of any 'soft spots/areas' and their replacement with well-compacted granular materials as previously described.

Please note that the Local Council / Highways Authority may require in-situ CBR testing to be undertaken before a road is adopted.

ANNEX A
Landmark Historical Maps



Monmouthshire

Published 1883 - 1884

Source map scale - 1:500

The 1:500 scale Ordnance Survey mapping was introduced in 1855 as a replacement for the 1:528 scale and to compliment the 1:2500 scale that had been implemented in 1853. By 1895, the 1:500 scale covered most towns over a population of about 4000 at the time of survey, although very few towns were mapped more than once at this scale, and none have been since 1910. The 1:500 scale gives particular emphasis to such features as lamp posts, man holes, arched passages and minor building projections. Also often featured are divisions between tenements, interior ground floor layouts of public buildings, and on earlier plans, the functions of the various parts of larger industrial premises are also indicated. Content of the plans does vary however, from one town to the next in terms of, for example, the completeness of railway tracks and the coverage of public buildings.

Please note: Due to the partial coverage of Historical Town Plans, it is possible that not all segments within an order will contain mapping. Only the segments that have Town Plan coverage will be generated.

Map Name(s) and Date(s)

| | |
|-----------------------------|-----------------------------|
| 028_16_009 1883 1:500 | 028_16_010 1884 1:500 |
| 028_16_014 1884 1:500 | 028_16_015 1883 1:500 |

Historical Town Plan - Segment A8

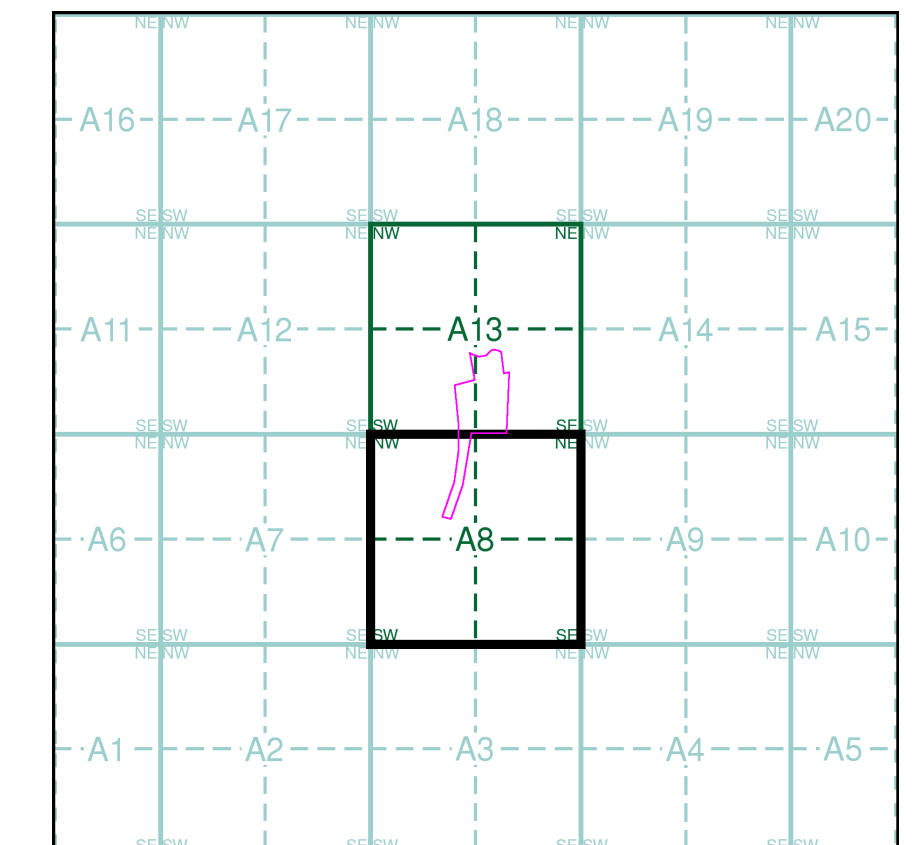

Order Details

Order Number: 41914630_1_1
 Customer Ref: 12044
 National Grid Reference: 331690, 189280
 Slice: A
 Site Area (Ha): 4.52
 Search Buffer (m): 0

Site Details

., Herbert Road, NEWPORT, Gwent, NP19 7BH



Tel: 0844 844 9952
 Fax: 0844 844 9951
 Web: www.envirocheck.co.uk

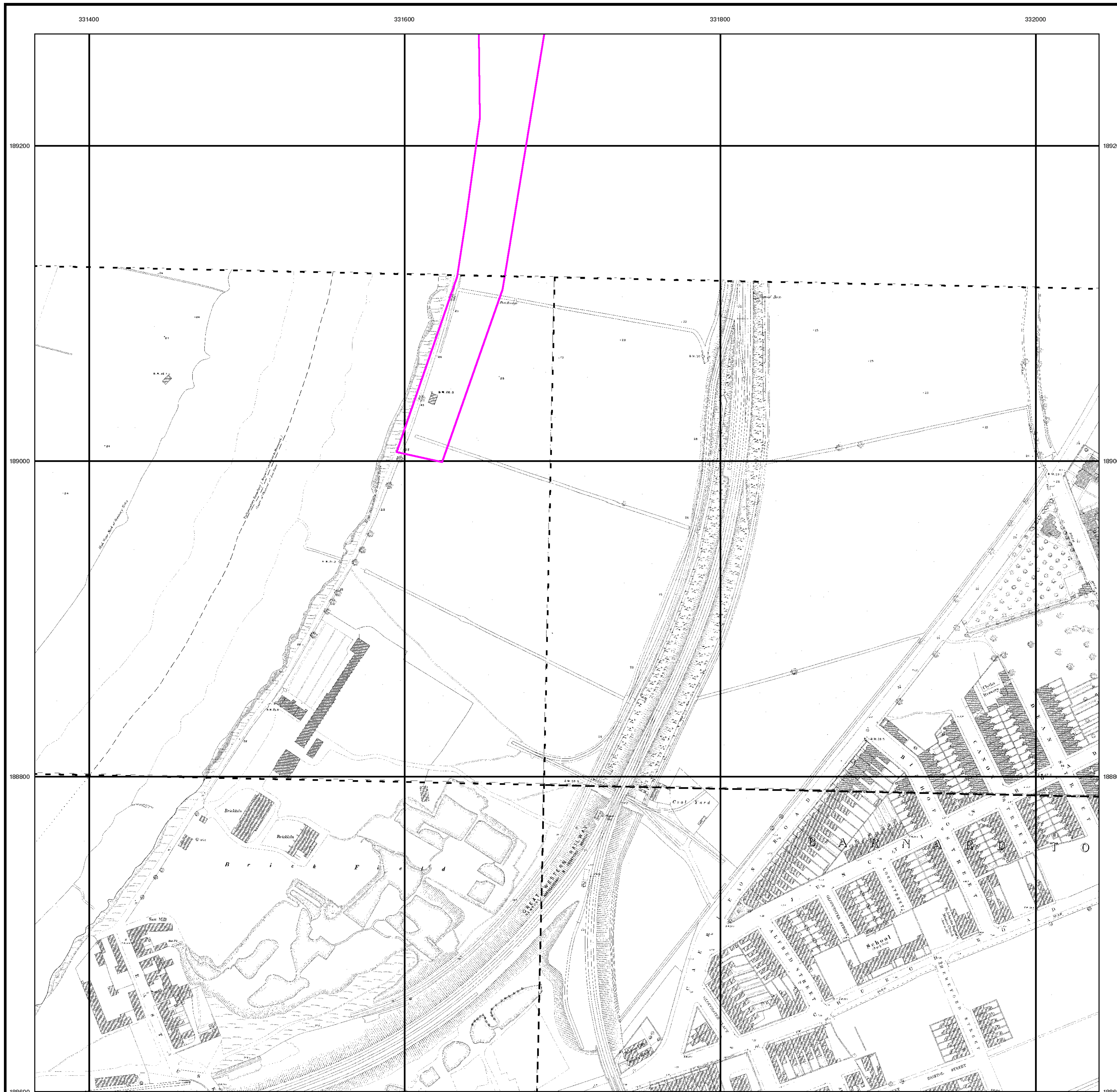

Historical Mapping Legends

Ordnance Survey County Series and Ordnance Survey Plan 1:2,500

Quarry **Gravel Pit** **Sand Pit**
Clay Pit **Shingle** **Refuse Heap**
Sloping Masonry **Flat Rock**
Marsh **Reeds** **Osiers**
Rough Pasture **Furze** **Wood**
Mixed Wood **Brushwood** **Orchard**
Fir **Ford** **Stepping Stones**
Ferry **Waterfall** **Lock**
Trig. Station **Altitude at Trig. Station**
B.M. 325.9 **Bench Mark** **Surface Level**
Arrow denotes flow of water **Antiquities (site of)**
Cutting **Embankment**
Railway crossing Road **Level Crossing** **Road crossing Railway**
Railway crossing River or Canal **Road over single stream** **Road over River or Canal**
County Boundary (Geographical)
County & Civil Parish Boundary
Administrative County & Civil Parish Boundary
County Borough Boundary (England)
County Burgh Boundary (Scotland)
Boundary Post or Stone **Police Call Box**
B.R. Bridle Road **Pump**
E.P. Electricity Pylon **S.P. Signal Post**
F.B. Foot Bridge **Sl. Sluice**
F.P. Foot Path **Sp. Spring**
G.P. Guide Post or Board **T.C.B. Telephone Call Box**
M.S. Mile Stone **Tr. Trough**
M.P. M.R. Mooring Post or Ring **W. Well**

Ordnance Survey Plan, Additional SIMs and Supply of Unpublished Survey Information 1:2,500 and 1:1,250

Inactive Quarry, Chalk Pit or Clay Pit **Active Quarry, Chalk Pit or Clay Pit**
Rock **Boulders**
Cliff **Slopes** **Top**
Roofed Building **Glazed Roof Building**
Sloping Masonry **Archway**
Non-Coniferous Tree (surveyed) **Coniferous Tree (surveyed)**
Non-Coniferous Trees (not surveyed) **Coniferous Trees (not surveyed)**
Orchard Tree **Scrub** **Bracken**
Coppice, Osier **Reeds** **Marsh, Saltings**
Rough Grassland **Heath** **Culvert**
Direction of water flow **Bench Mark** **Antiquity (site of)**
Cave Entrance **Triangulation Station** **Electricity Pylon**
Electricity Transmission Line
County Boundary (Geographical)
County & Civil Parish Boundary
Civil Parish Boundary
Admin. County or County Bor. Boundary
London Borough Boundary
Symbol marking point where boundary mereing changes
BH Beer House **P Pillar, Pole or Post**
BP, BS Boundary Post or Stone **PO Post Office**
Cn, C Capstan, Crane **PC Public Convenience**
Chy Chimney **PH Public House**
D Fn Drinking Fountain **Pp Pump**
EI P Electricity Pillar or Post **SB, S Br Signal Box or Bridge**
FAP Fire Alarm Pillar **SP, SL Signal Post or Light**
FB Foot Bridge **Spr Spring**
GP Guide Post **Tk Tank or Track**
H Hydrant or Hydraulic **TCB Telephone Call Box**
LC Level Crossing **TCP Telephone Call Post**
MH Manhole **Tr Trough**
MP Mile Post or Mooring Post **Wr Pt, Wr T Water Point, Water Tap**
MS Mile Stone **W Well**
NTL Normal Tidal Limit **Wd Pp Wind Pump**

Large-Scale National Grid Data 1:2,500 and 1:1,250

Cliff **Slopes** **Top**
Rock **Rock (scattered)**
Boulders **Boulders (scattered)**
Positioned Boulder **Scree**
Non-Coniferous Tree (surveyed) **Coniferous Tree (surveyed)**
Non-Coniferous Trees (not surveyed) **Coniferous Trees (not surveyed)**
Orchard Tree **Scrub** **Bracken**
Coppice, Osier **Reeds** **Marsh, Saltings**
Rough Grassland **Heath** **Culvert**
Direction of water flow **Triangulation Station** **Antiquity (site of)**
Electricity Transmission Line **Electricity Pylon**
Bench Mark **Buildings with Building Seed**
Roofed Building **Glazed Roof Building**
Civil parish/community boundary
District boundary
County boundary
Boundary post/stone
Boundary mereing symbol (note: these always appear in opposed pairs or groups of three)
Bks Barracks **P Pillar, Pole or Post**
Bty Battery **PO Post Office**
Cemy Cemetery **PC Public Convenience**
Chy Chimney **Pp Pump**
Cis Cistern **Ppg Sta Pumping Station**
Dismtd Rly Dismantled Railway **PW Place of Worship**
EI Gen Sta Electricity Generating Station **Sewage Ppg Sta Sewage Pumping Station**
EI P Electricity Pole, Pillar **SB, S Br Signal Box or Bridge**
EI Sub Sta Electricity Sub Station **SP, SL Signal Post or Light**
FB Filter Bed **Spr Spring**
Fn / D Fn Fountain / Drinking Ftn. **Tk Tank or Track**
Gas Gov Gas Valve Compound **Tr Trough**
GVC Gas Governor **Wd Pp Wind Pump**
GP Guide Post **Wr Pt, Wr T Water Point, Water Tap**
MH Manhole **Wks Works (building or area)**
MP, MS Mile Post or Mile Stone **W Well**



Historical Mapping & Photography included:

| Mapping Type | Scale | Date | Pg |
|--|---------|-------------|----|
| Monmouthshire | 1:2,500 | 1883 | 2 |
| Monmouthshire | 1:2,500 | 1901 - 1902 | 3 |
| Monmouthshire | 1:2,500 | 1920 | 4 |
| Monmouthshire | 1:2,500 | 1936 - 1937 | 5 |
| Ordnance Survey Plan | 1:2,500 | 1955 - 1957 | 6 |
| Ordnance Survey Plan | 1:1,250 | 1955 - 1957 | 7 |
| Additional SIMs | 1:1,250 | 1957 - 1989 | 8 |
| Ordnance Survey Plan | 1:1,250 | 1966 - 1968 | 9 |
| Ordnance Survey Plan | 1:2,500 | 1969 - 1970 | 10 |
| Supply of Unpublished Survey Information | 1:1,250 | 1974 | 11 |
| Ordnance Survey Plan | 1:1,250 | 1977 | 12 |
| Additional SIMs | 1:1,250 | 1978 - 1989 | 13 |
| Additional SIMs | 1:1,250 | 1989 | 14 |
| Large-Scale National Grid Data | 1:1,250 | 1993 | 15 |
| Large-Scale National Grid Data | 1:1,250 | 1994 - 1995 | 16 |
| Large-Scale National Grid Data | 1:1,250 | 1995 - 1997 | 17 |
| Large-Scale National Grid Data | 1:1,250 | 1995 | 18 |

Historical Map - Segment A13

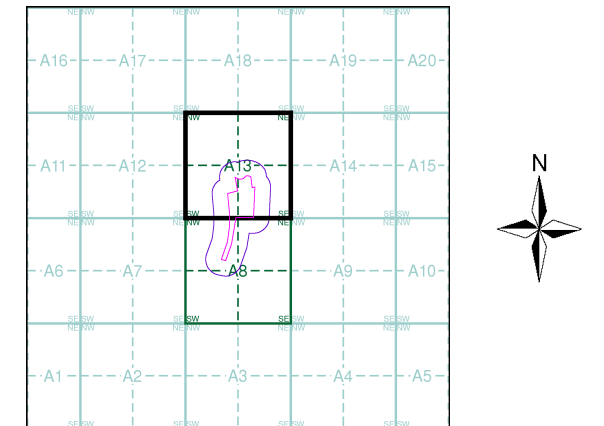

Order Details

Order Number: 41914630_1_1
 Customer Ref: 12044
 National Grid Reference: 331690, 189280
 Slice: A
 Site Area (Ha): 4.52
 Search Buffer (m): 100

Site Details

., Herbert Road, NEWPORT, Gwent, NP19 7BH



Tel: 0844 844 9952
 Fax: 0844 844 9951
 Web: www.envirocheck.co.uk

The historical maps shown were reproduced from maps predominantly held at the scale adopted for England, Wales and Scotland in the 1840's. In 1854 the 1:2,500 scale was adopted for mapping urban areas and by 1896 it covered the whole of what were considered to be the cultivated parts of Great Britain. The published date given below is often some years later than the surveyed date. Before 1938, all OS maps were based on the Cassini Projection, with independent surveys of a single county or group of counties, giving rise to significant inaccuracies in outlying areas.

Map Name(s) and Date(s)

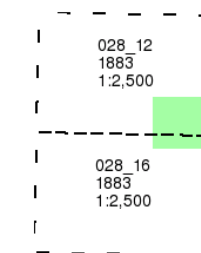

Historical Map - Segment A13

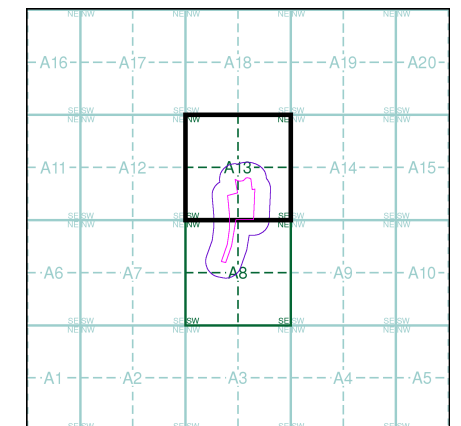

Order Details

Order Number: 41914630_1_1
 Customer Ref: 12044
 National Grid Reference: 331690, 189280
 Slice: A
 Site Area (Ha): 4.52
 Search Buffer (m): 100

Site Details

Herbert Road, NEWPORT, Gwent, NP19 7BH

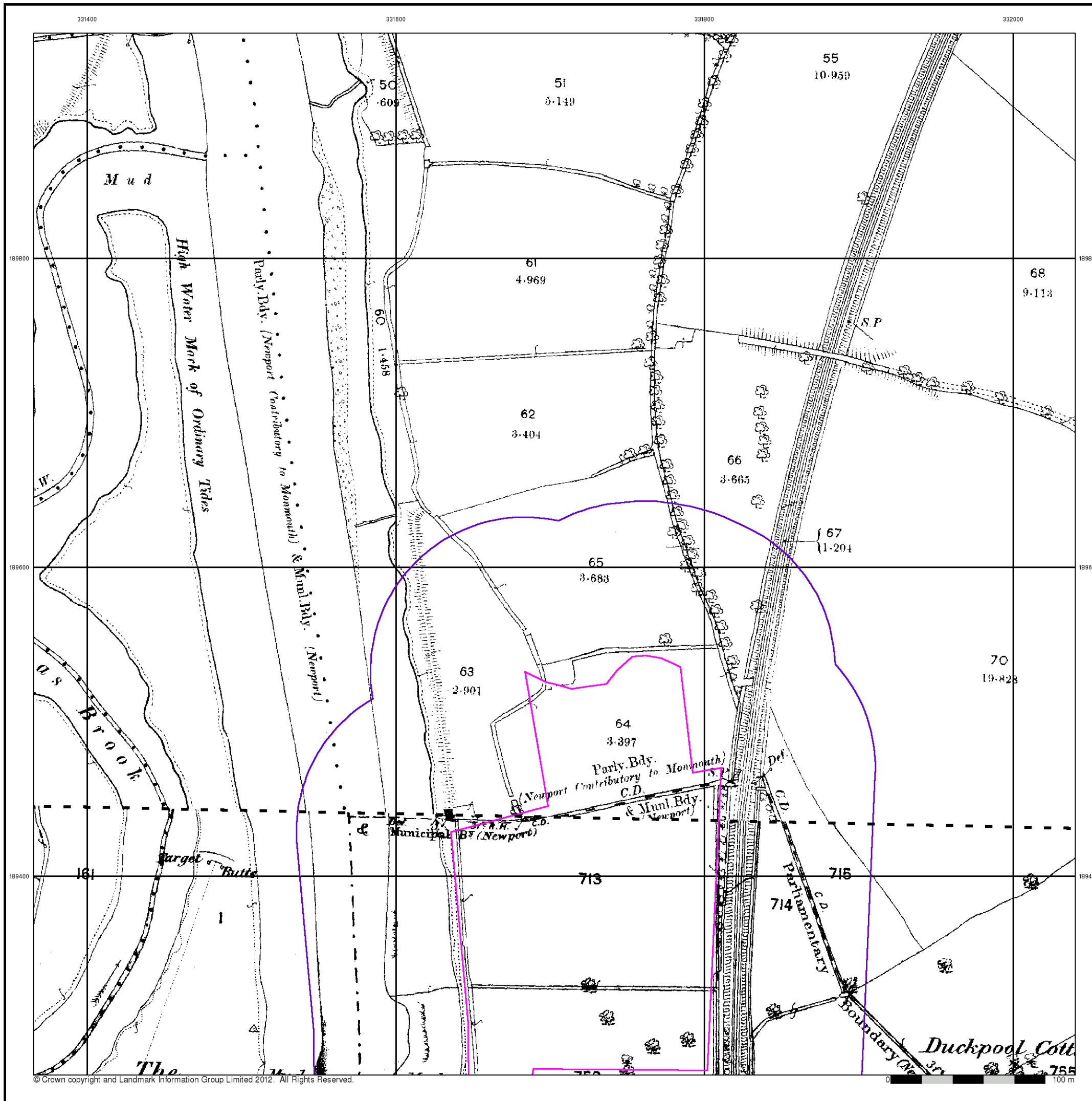



Monmouthshire

Published 1901 - 1902

Source map scale - 1:2,500

The historical maps shown were reproduced from maps predominantly held at the scale adopted for England, Wales and Scotland in the 1840's. In 1854 the 1:2,500 scale was adopted for mapping urban areas and by 1896 it covered the whole of what were considered to be the cultivated parts of Great Britain. The published date given below is often some years later than the surveyed date. Before 1938, all OS maps were based on the Cassini Projection, with independent surveys of a single county or group of counties, giving rise to significant inaccuracies in outlying areas.

Map Name(s) and Date(s)

| | | |
|--------|------|---------|
| 028_12 | 1901 | 1:2,500 |
| 028_16 | 1902 | 1:2,500 |

Historical Map - Segment A13

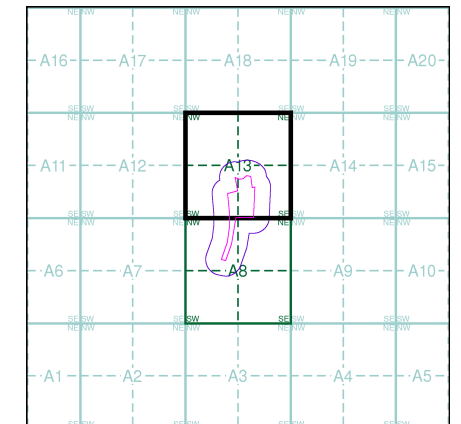

Order Details

Order Number: 41914630_1_1
 Customer Ref: 12044
 National Grid Reference: 331690, 189280
 Slice: A
 Site Area (Ha): 4.52
 Search Buffer (m): 100

Site Details

Herbert Road, NEWPORT, Gwent, NP19 7BH



Tel: 0844 844 9952
 Fax: 0844 844 9951
 Web: www.envirocheck.co.uk

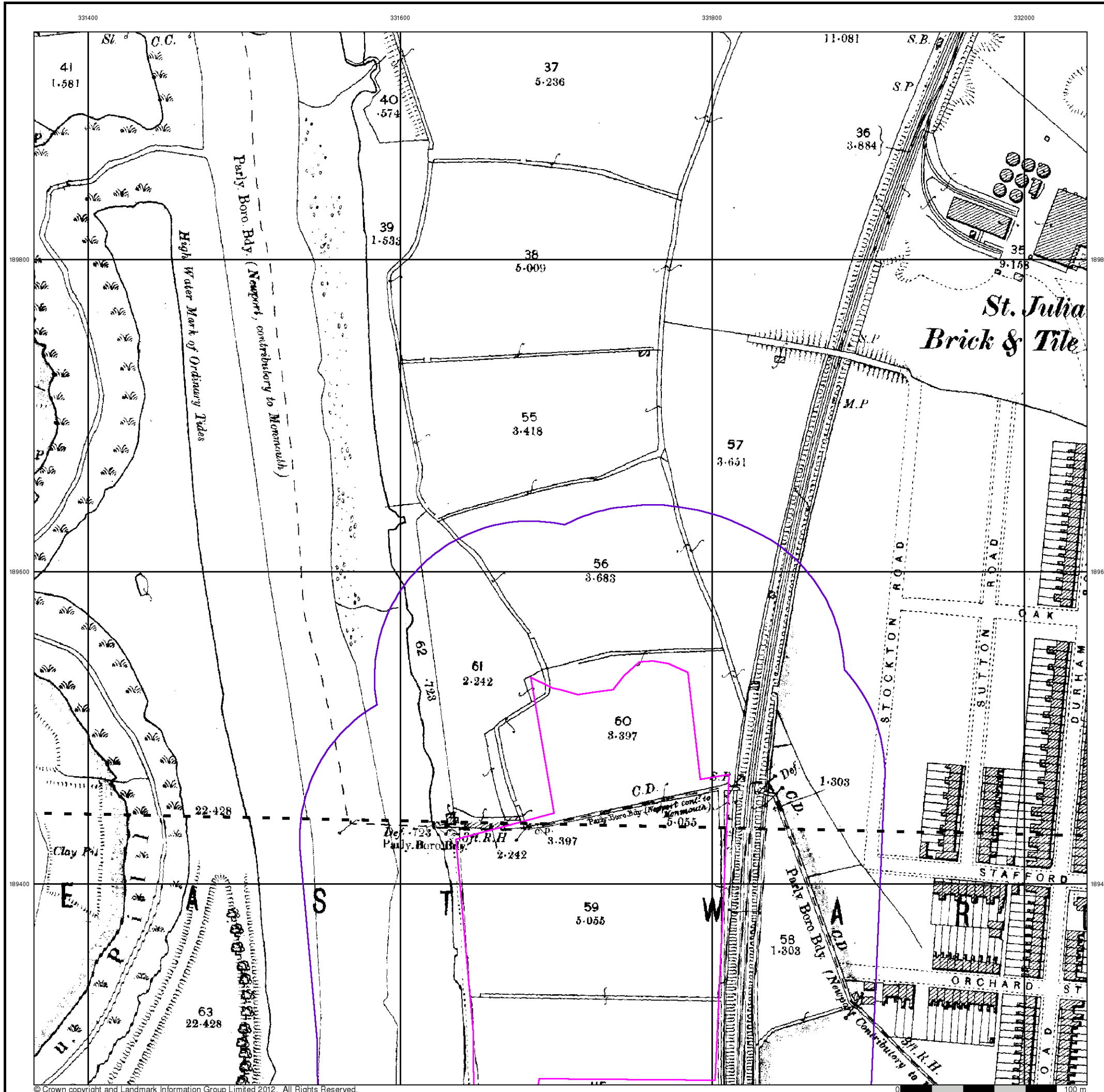



Monmouthshire

Published 1920

Source map scale - 1:2,500

The historical maps shown were reproduced from maps predominantly held at the scale adopted for England, Wales and Scotland in the 1840's. In 1854 the 1:2,500 scale was adopted for mapping urban areas and by 1896 it covered the whole of what were considered to be the cultivated parts of Great Britain. The published date given below is often some years later than the surveyed date. Before 1938, all OS maps were based on the Cassini Projection, with independent surveys of a single county or group of counties, giving rise to significant inaccuracies in outlying areas.

Map Name(s) and Date(s)

| | | |
|--------|------|---------|
| 028_12 | 1920 | 1:2,500 |
| 028_16 | 1920 | 1:2,500 |

Historical Map - Segment A13

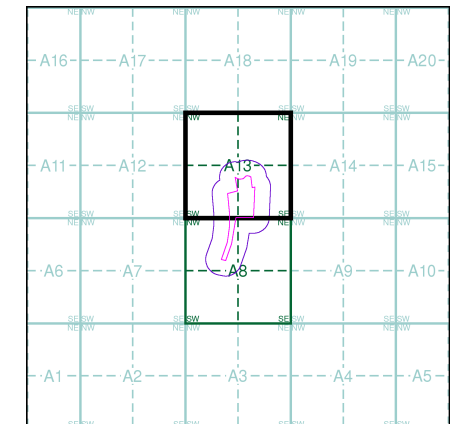

Order Details

Order Number: 41914630_1_1
 Customer Ref: 12044
 National Grid Reference: 331690, 189280
 Slice: A
 Site Area (Ha): 4.52
 Search Buffer (m): 100

Site Details

Herbert Road, NEWPORT, Gwent, NP19 7BH



Tel: 0844 844 9952
 Fax: 0844 844 9951
 Web: www.envirocheck.co.uk

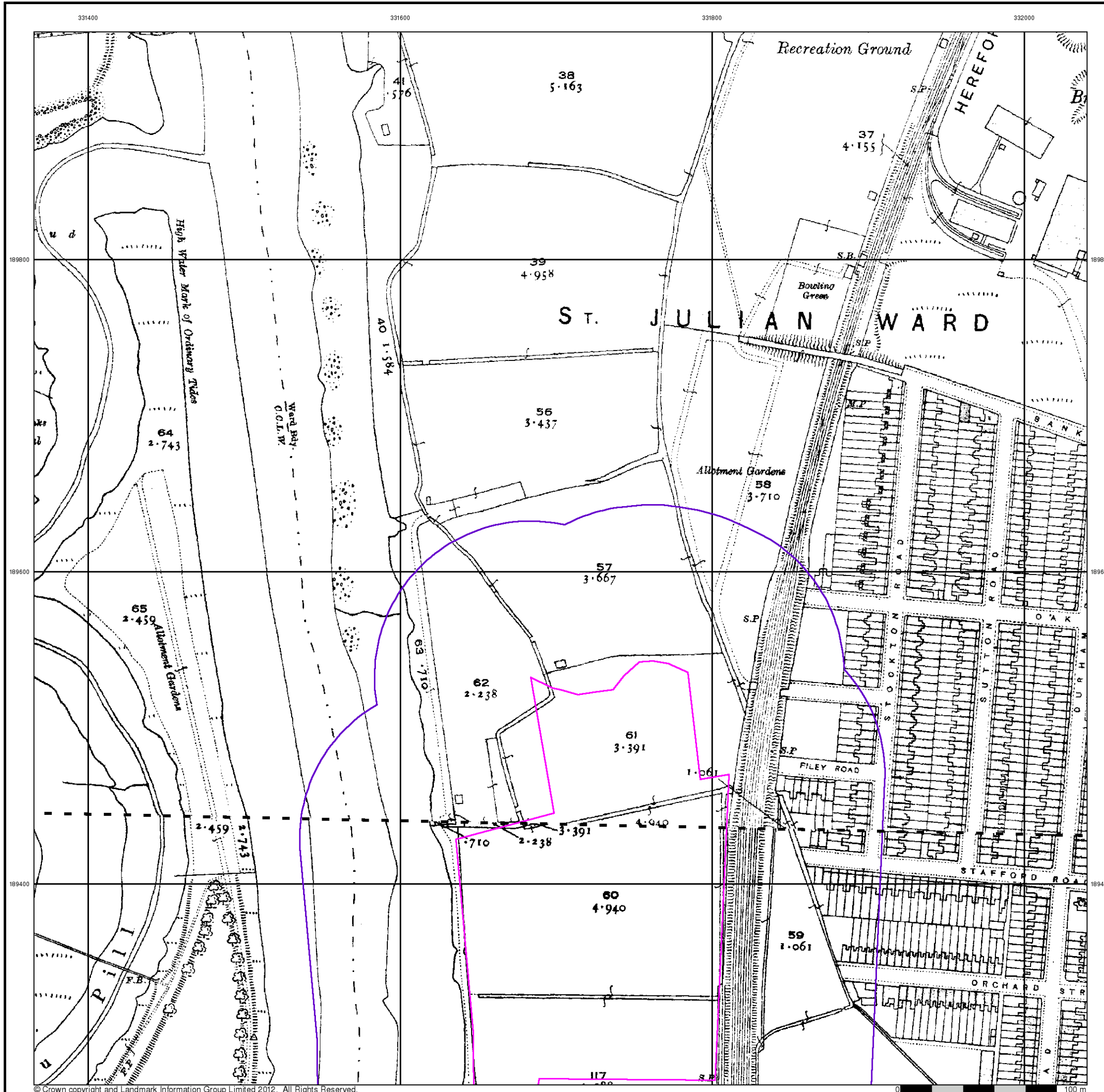

The historical maps shown were reproduced from maps predominantly held at the scale adopted for England, Wales and Scotland in the 1840's. In 1854 the 1:2,500 scale was adopted for mapping urban areas and by 1896 it covered the whole of what were considered to be the cultivated parts of Great Britain. The published date given below is often some years later than the surveyed date. Before 1938, all OS maps were based on the Cassini Projection, with independent surveys of a single county or group of counties, giving rise to significant inaccuracies in outlying areas.

Map Name(s) and Date(s)

| | | |
|--------|------|---------|
| 028_12 | 1936 | 1:2,500 |
| 028_16 | 1937 | 1:2,500 |

Historical Map - Segment A13

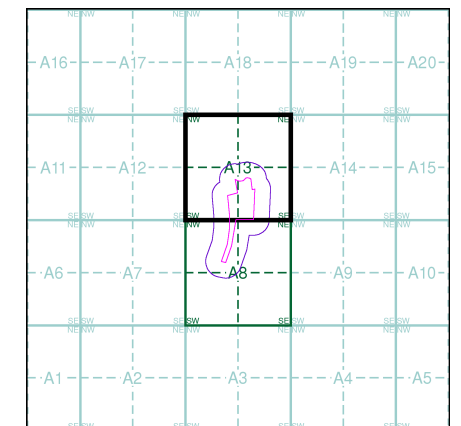

Order Details

Order Number: 41914630_1_1
 Customer Ref: 12044
 National Grid Reference: 331690, 189280
 Slice: A
 Site Area (Ha): 4.52
 Search Buffer (m): 100

Site Details

Herbert Road, NEWPORT, Gwent, NP19 7BH

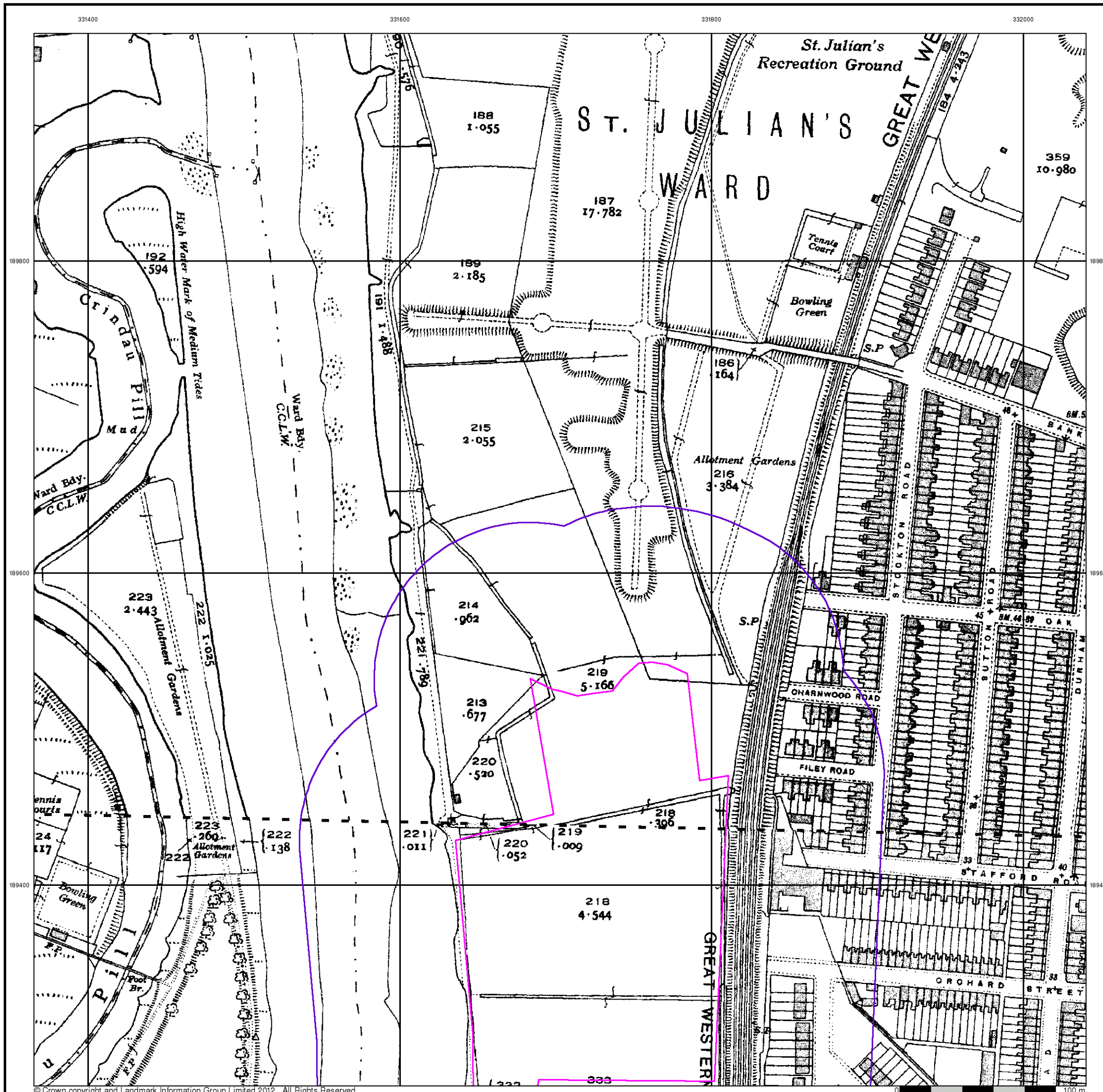



Ordnance Survey Plan

Published 1955 - 1957

Source map scale - 1:2,500

The historical maps shown were reproduced from maps predominantly held at the scale adopted for England, Wales and Scotland in the 1840's. In 1854 the 1:2,500 scale was adopted for mapping urban areas and by 1896 it covered the whole of what were considered to be the cultivated parts of Great Britain. The published date given below is often some years later than the surveyed date. Before 1938, all OS maps were based on the Cassini Projection, with independent surveys of a single county or group of counties, giving rise to significant inaccuracies in outlying areas.

Map Name(s) and Date(s)

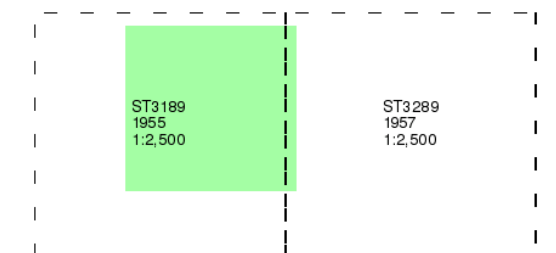

Historical Map - Segment A13

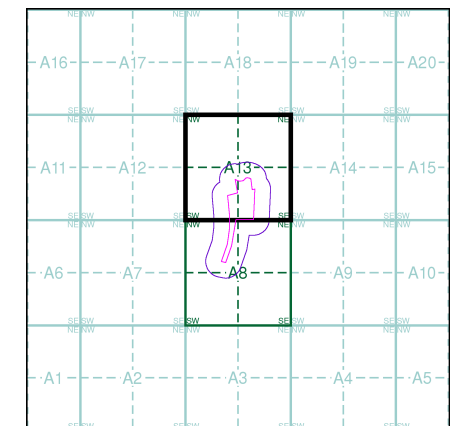

Order Details

Order Number: 41914630_1_1
Customer Ref: 12044
National Grid Reference: 331690, 189280
Slice: A
Site Area (Ha): 4.52
Search Buffer (m): 100

Site Details

Herbert Road, NEWPORT, Gwent, NP19 7BH



Tel: 0844 844 9952
Fax: 0844 844 9951
Web: www.envirocheck.co.uk

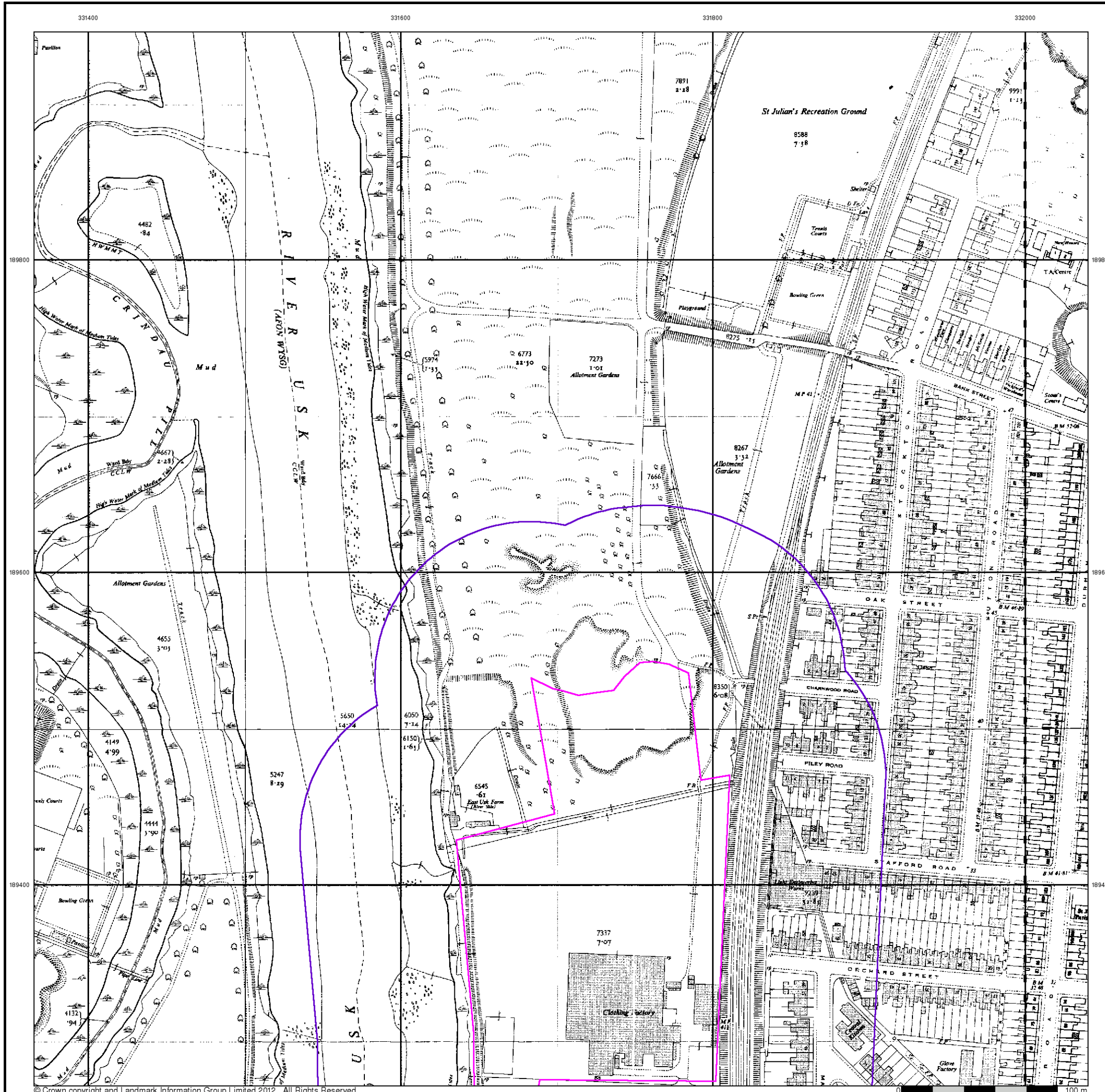



Ordnance Survey Plan

Published 1955 - 1957

Source map scale - 1:1,250

The historical maps shown were reproduced from maps predominantly held at the scale adopted for England, Wales and Scotland in the 1840's. In 1854 the 1:2,500 scale was adopted for mapping urban areas and by 1896 it covered the whole of what were considered to be the cultivated parts of Great Britain. The published date given below is often some years later than the surveyed date. Before 1938, all OS maps were based on the Cassini Projection, with independent surveys of a single county or group of counties, giving rise to significant inaccuracies in outlying areas.

Map Name(s) and Date(s)

| | | |
|------------------------------|------------------------------|------------------------------|
| ST3 189NW 1955 1:1,250 | ST3 189NE 1955 1:1,250 | ST3 289NW 1957 1:1,250 |
| ST3 189SW 1955 1:1,250 | ST3 189SE 1955 1:1,250 | ST3 289SW 1957 1:1,250 |

Historical Map - Segment A13

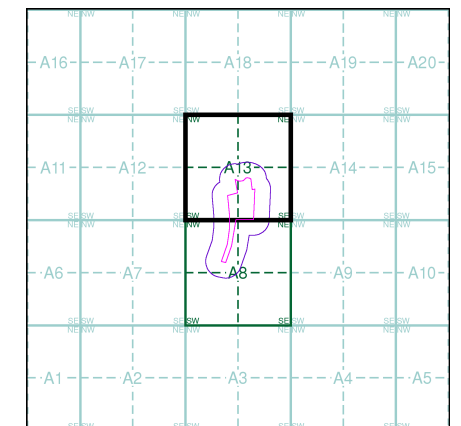

Order Details

Order Number: 41914630_1_1
 Customer Ref: 12044
 National Grid Reference: 331690, 189280
 Slice: A
 Site Area (Ha): 4.52
 Search Buffer (m): 100

Site Details

Herbert Road, NEWPORT, Gwent, NP19 7BH



Tel: 0844 844 9952
 Fax: 0844 844 9951
 Web: www.envirocheck.co.uk

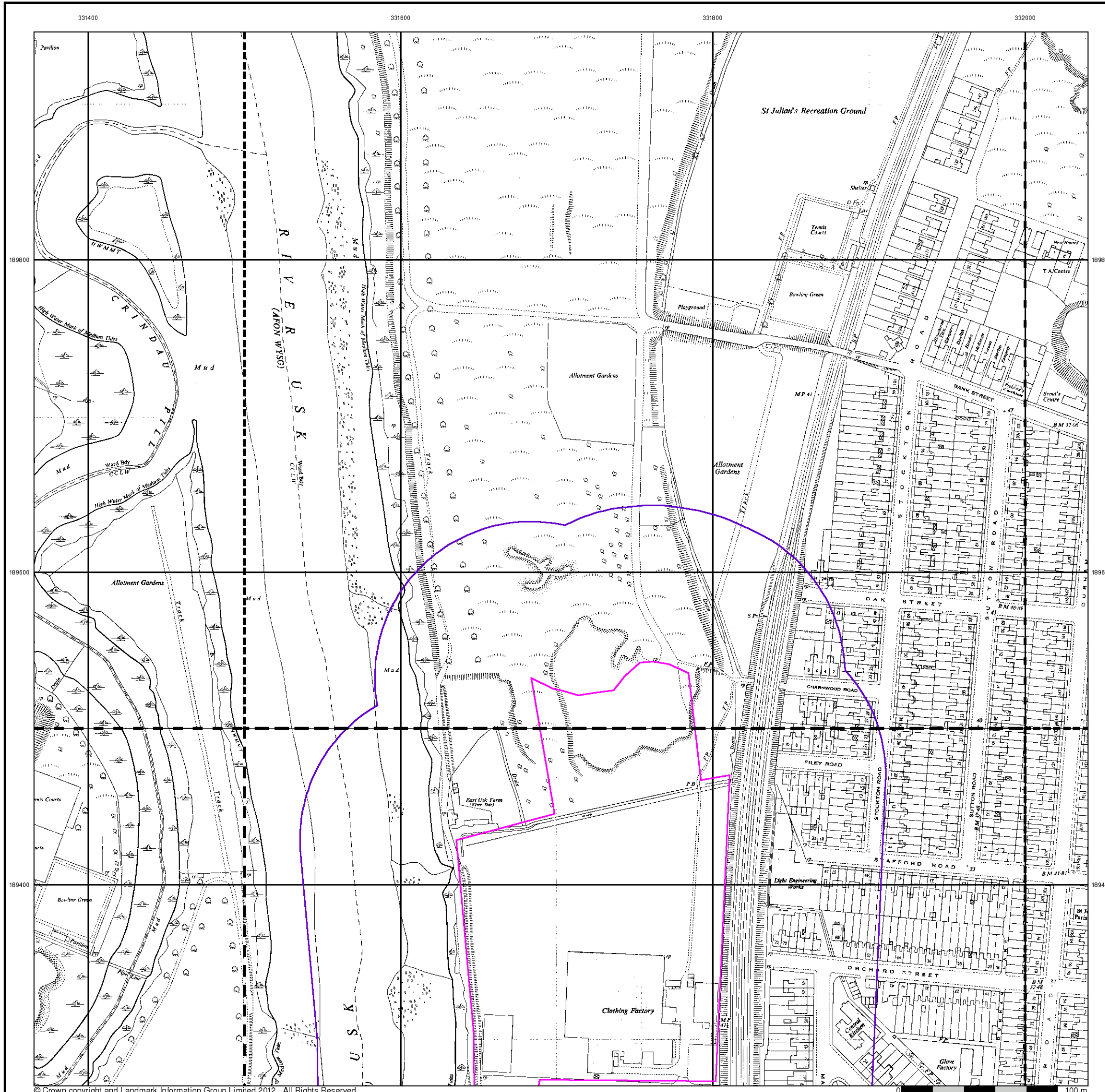



Additional SIMs

Published 1957 - 1989

Source map scale - 1:1,250

The SIM cards (Ordnance Survey's 'Survey of Information on Microfilm') are further, minor editions of mapping which were produced and published in between the main editions as an area was updated. They date from 1947 to 1994, and contain detailed information on buildings, roads and land-use. These maps were produced at both 1:2,500 and 1:1,250 scales.

Map Name(s) and Date(s)

| | | |
|------------------------------|------------------------------|------------------------------|
| ST3 189NW 1989 1:1,250 | ST3 189NE 1986 1:1,250 | ST3 289NW 1988 1:1,250 |
| ST3 189SW 1982 1:1,250 | ST3 189SE 1978 1:1,250 | ST3 289SW 1957 1:1,250 |

Historical Map - Segment A13

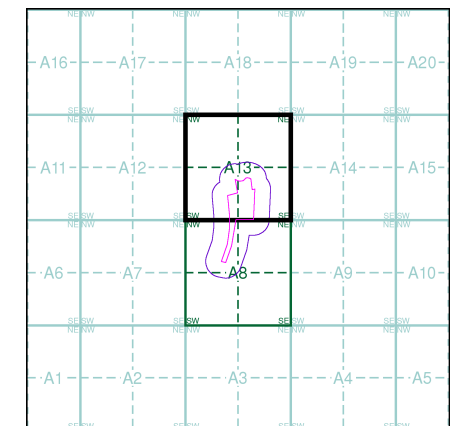

Order Details

Order Number: 41914630_1_1
 Customer Ref: 12044
 National Grid Reference: 331690, 189280
 Slice: A
 Site Area (Ha): 4.52
 Search Buffer (m): 100

Site Details

., Herbert Road, NEWPORT, Gwent, NP19 7BH



Tel: 0844 844 9952
 Fax: 0844 844 9951
 Web: www.envirocheck.co.uk

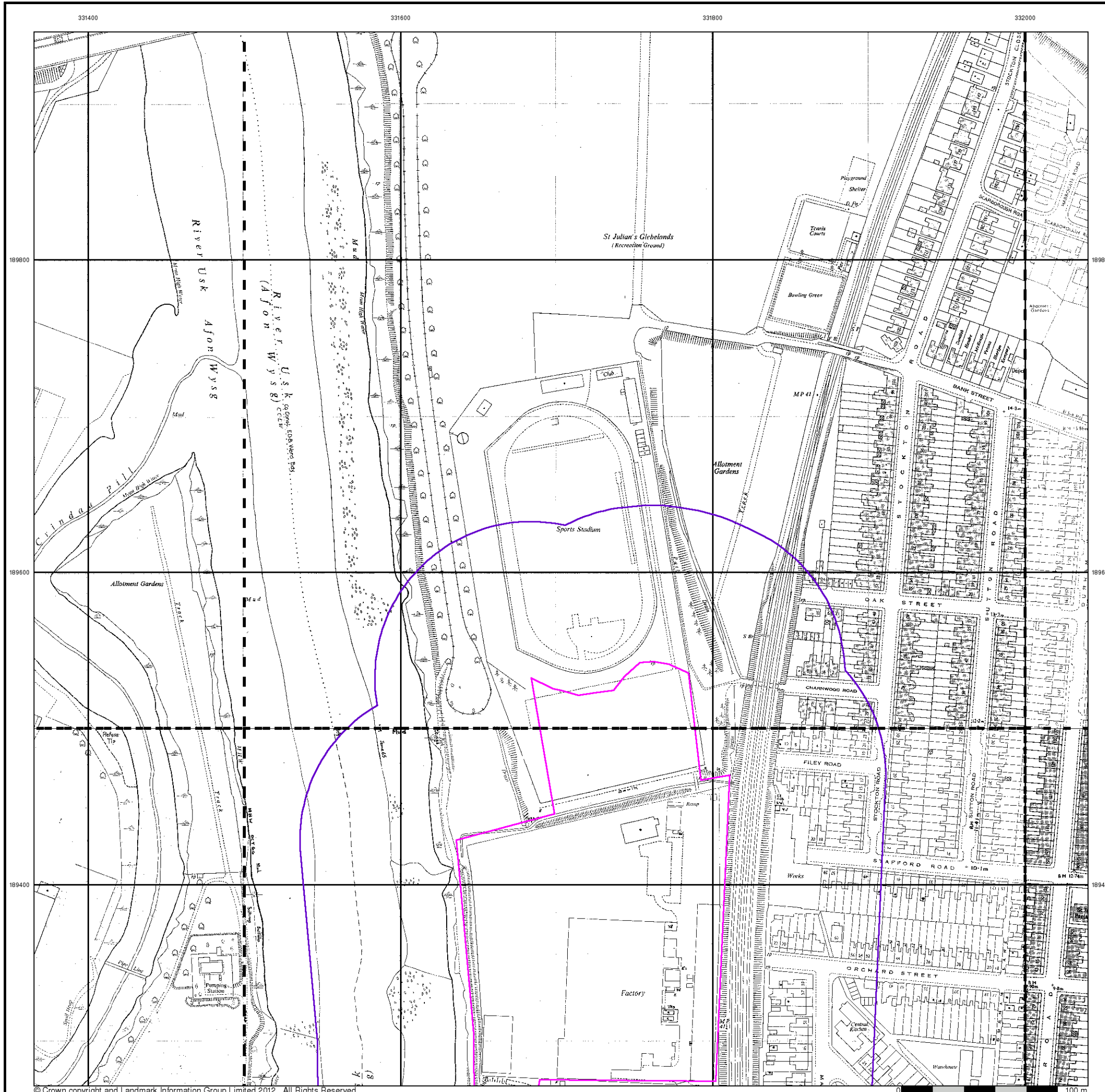



Ordnance Survey Plan

Published 1966 - 1968

Source map scale - 1:1,250

The historical maps shown were reproduced from maps predominantly held at the scale adopted for England, Wales and Scotland in the 1840's. In 1854 the 1:2,500 scale was adopted for mapping urban areas and by 1896 it covered the whole of what were considered to be the cultivated parts of Great Britain. The published date given below is often some years later than the surveyed date. Before 1938, all OS maps were based on the Cassini Projection, with independent surveys of a single county or group of counties, giving rise to significant inaccuracies in outlying areas.

Map Name(s) and Date(s)

| | | |
|-----------------------------|-----------------------------|-----------------------------|
| ST3189NW 1968 1:1,250 | ST3189NE 1968 1:1,250 | ST3289NW 1968 1:1,250 |
| ST3189SW 1967 1:1,250 | ST3189SE 1966 1:1,250 | |

Historical Map - Segment A13

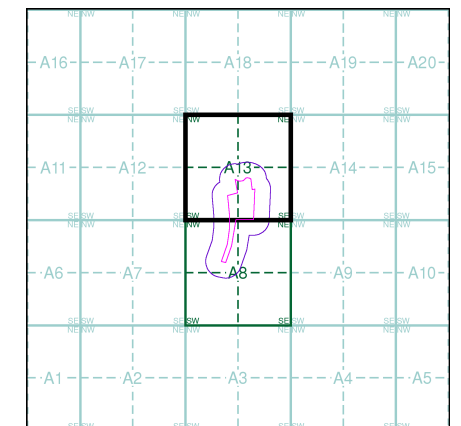

Order Details

Order Number: 41914630_1_1
 Customer Ref: 12044
 National Grid Reference: 331690, 189280
 Slice: A
 Site Area (Ha): 4.52
 Search Buffer (m): 100

Site Details

., Herbert Road, NEWPORT, Gwent, NP19 7BH



Tel: 0844 844 9952
 Fax: 0844 844 9951
 Web: www.envirocheck.co.uk





Ordnance Survey Plan

Published 1969 - 1970

Source map scale - 1:2,500

The historical maps shown were reproduced from maps predominantly held at the scale adopted for England, Wales and Scotland in the 1840's. In 1854 the 1:2,500 scale was adopted for mapping urban areas and by 1896 it covered the whole of what were considered to be the cultivated parts of Great Britain. The published date given below is often some years later than the surveyed date. Before 1938, all OS maps were based on the Cassini Projection, with independent surveys of a single county or group of counties, giving rise to significant inaccuracies in outlying areas.

Map Name(s) and Date(s)

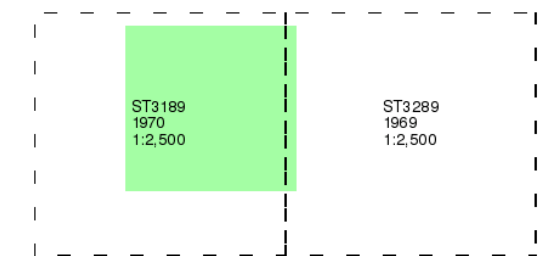

Historical Map - Segment A13

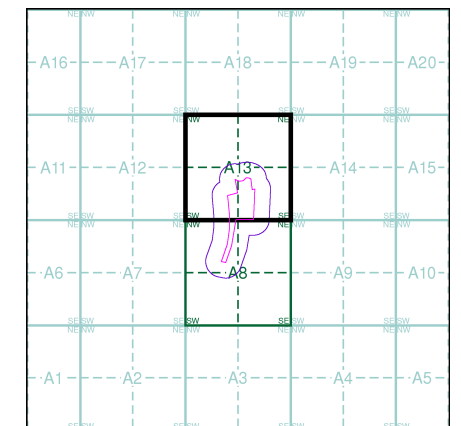

Order Details

Order Number: 41914630_1_1
Customer Ref: 12044
National Grid Reference: 331690, 189280
Slice: A
Site Area (Ha): 4.52
Search Buffer (m): 100

Site Details

Herbert Road, NEWPORT, Gwent, NP19 7BH



Tel: 0844 844 9952
Fax: 0844 844 9951
Web: www.envirocheck.co.uk

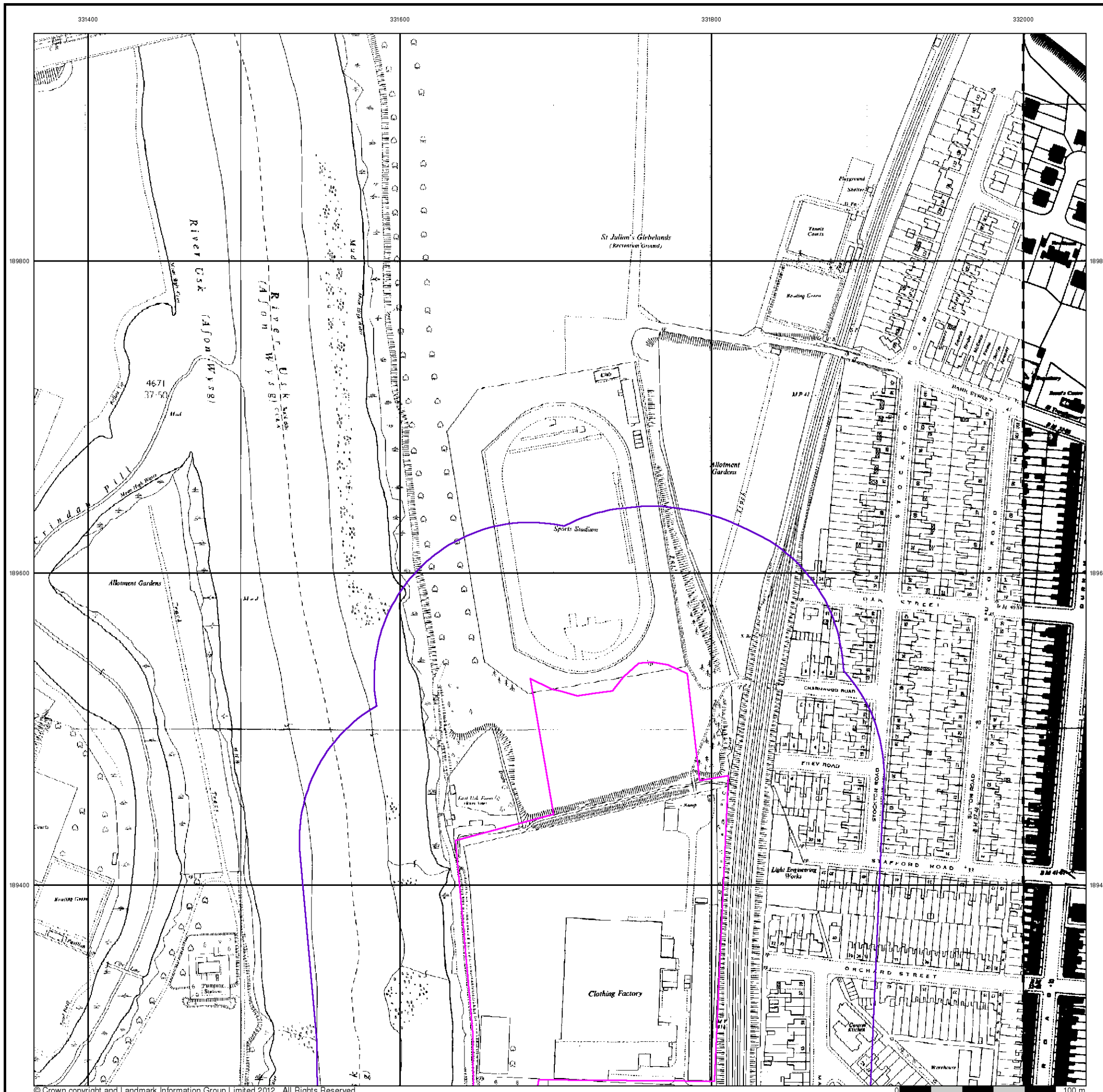



Supply of Unpublished Survey Information

Published 1974

Source map scale - 1:1,250

SUSI maps (Supply of Unpublished Survey Information) were produced between 1972 and 1977, mainly for internal use at Ordnance Survey. These were more of a 'work-in-progress' plan as they showed updates of individual areas on a map. These maps were unpublished, and they do not represent a single moment in time. They were produced at both 1:2,500 and 1:1,250 scales.

Map Name(s) and Date(s)

| | | |
|----------|------|---------|
| ST3189NW | 1974 | 1:1,250 |
| ST3189SW | 1974 | 1:1,250 |

Historical Map - Segment A13

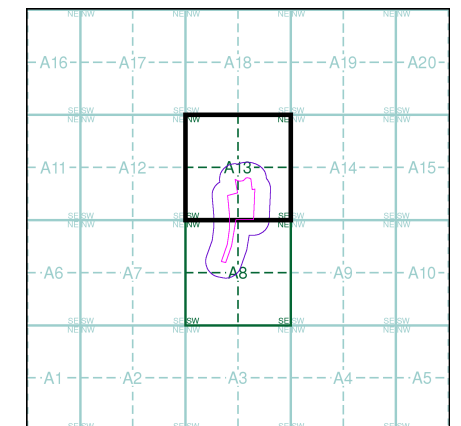

Order Details

Order Number: 41914630_1_1
Customer Ref: 12044
National Grid Reference: 331690, 189280
Slice: A
Site Area (Ha): 4.52
Search Buffer (m): 100

Site Details

., Herbert Road, NEWPORT, Gwent, NP19 7BH



Tel: 0844 844 9952
Fax: 0844 844 9951
Web: www.envirocheck.co.uk

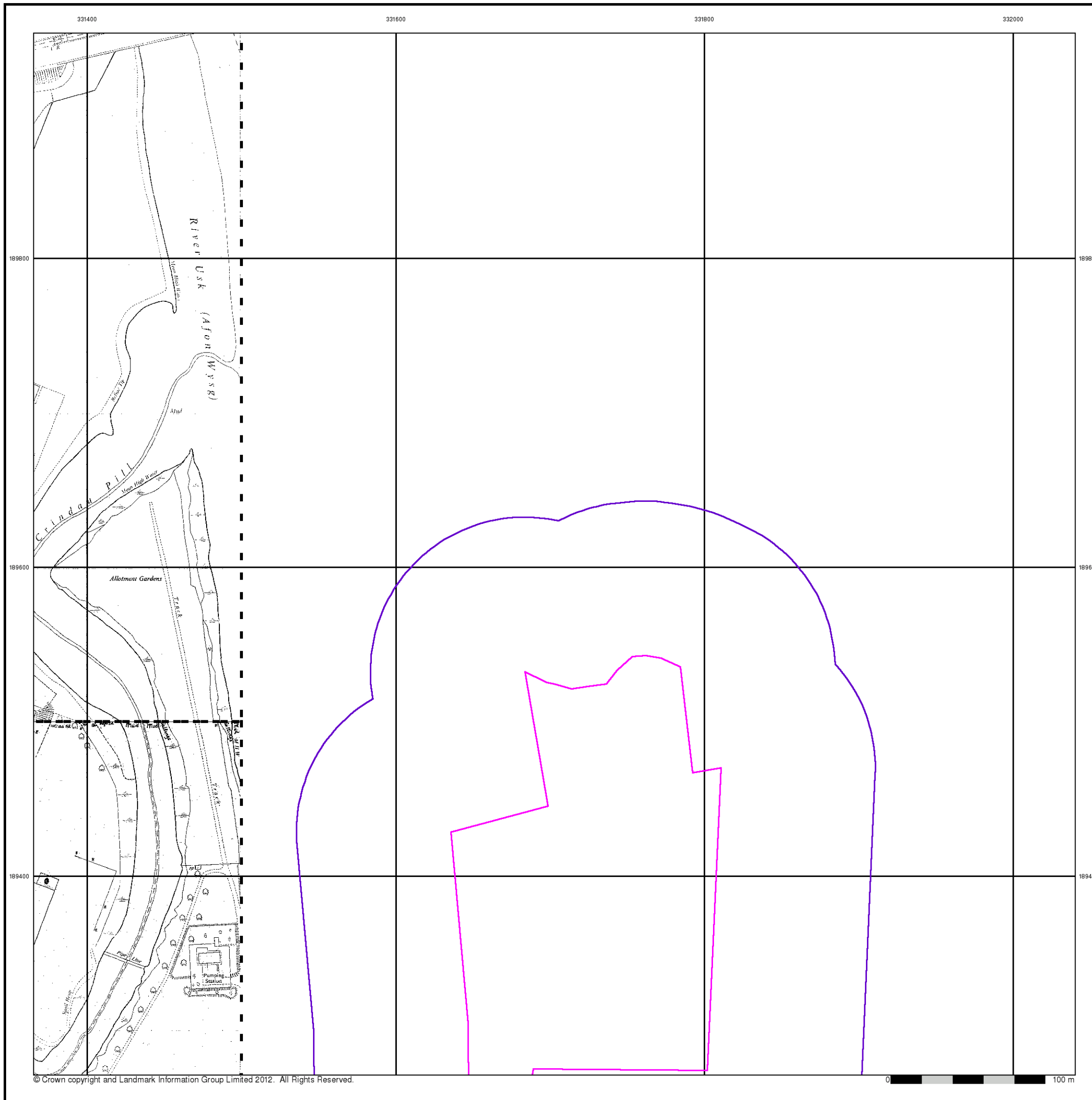



Ordnance Survey Plan

Published 1977

Source map scale - 1:1,250

The historical maps shown were reproduced from maps predominantly held at the scale adopted for England, Wales and Scotland in the 1840's. In 1854 the 1:2,500 scale was adopted for mapping urban areas and by 1896 it covered the whole of what were considered to be the cultivated parts of Great Britain. The published date given below is often some years later than the surveyed date. Before 1938, all OS maps were based on the Cassini Projection, with independent surveys of a single county or group of counties, giving rise to significant inaccuracies in outlying areas.

Map Name(s) and Date(s)

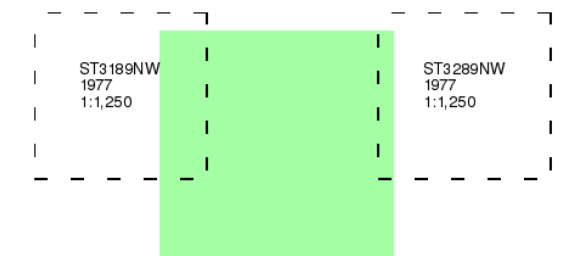

Historical Map - Segment A13

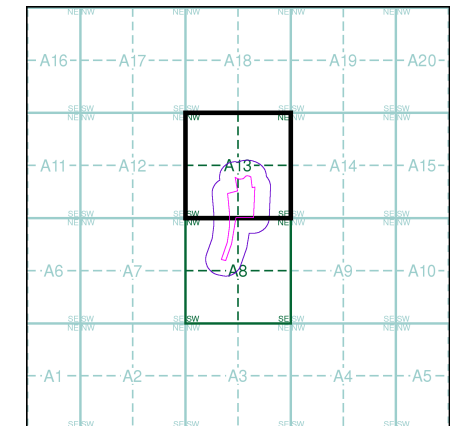

Order Details

Order Number: 41914630_1_1
Customer Ref: 12044
National Grid Reference: 331690, 189280
Slice: A
Site Area (Ha): 4.52
Search Buffer (m): 100

Site Details

., Herbert Road, NEWPORT, Gwent, NP19 7BH



Tel: 0844 844 9952
Fax: 0844 844 9951
Web: www.envirocheck.co.uk

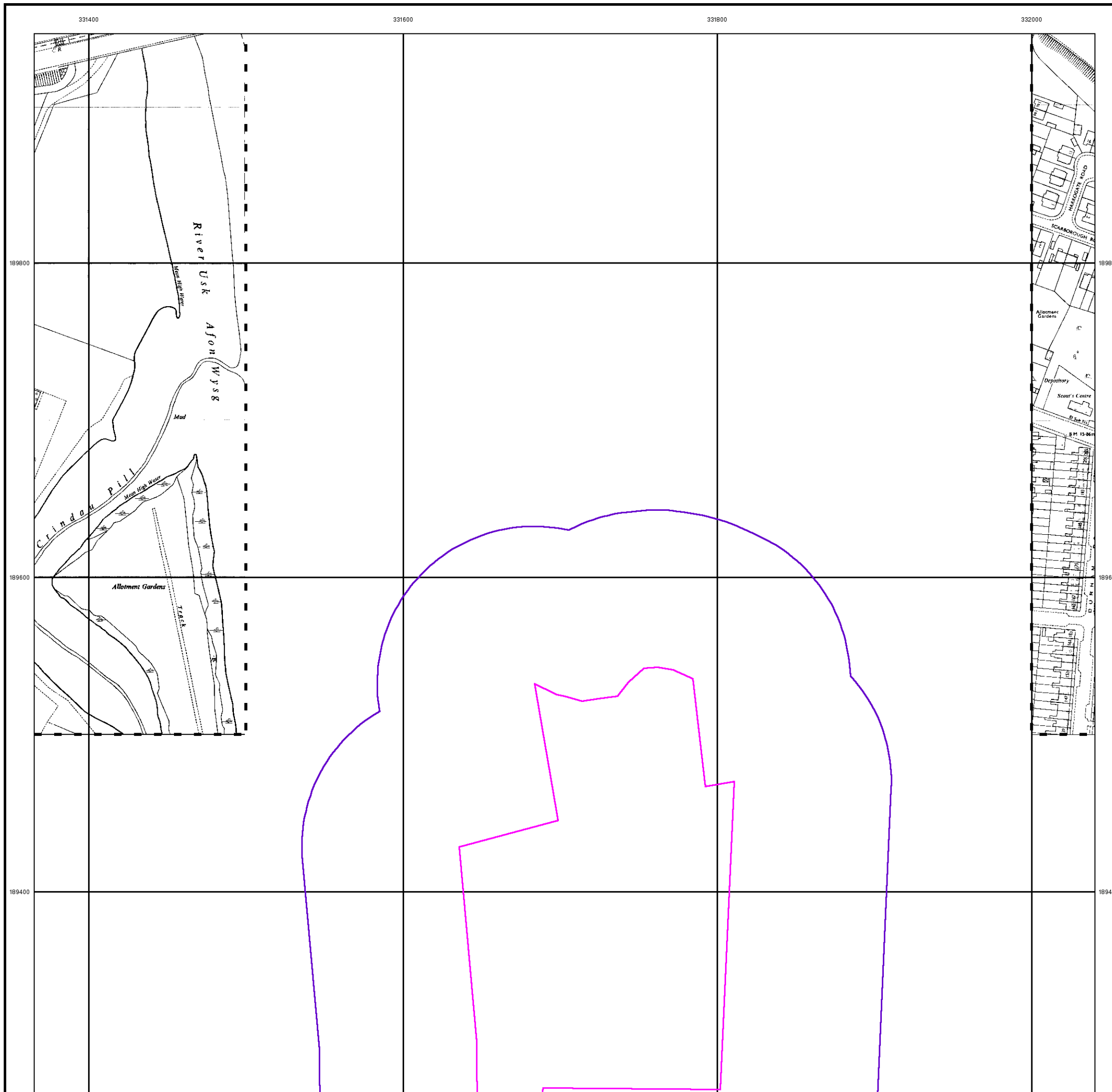



Additional SIMs

Published 1978 - 1989

Source map scale - 1:1,250

The SIM cards (Ordnance Survey's 'Survey of Information on Microfilm') are further, minor editions of mapping which were produced and published in between the main editions as an area was updated. They date from 1947 to 1994, and contain detailed information on buildings, roads and land-use. These maps were produced at both 1:2,500 and 1:1,250 scales.

Map Name(s) and Date(s)

| | | |
|-----------------------------|-----------------------------|-----------------------------|
| | | ST3289NW 1989 1:1,250 |
| ST3189SW 1987 1:1,250 | ST3189SE 1987 1:1,250 | ST3289SW 1978 1:1,250 |

Historical Map - Segment A13

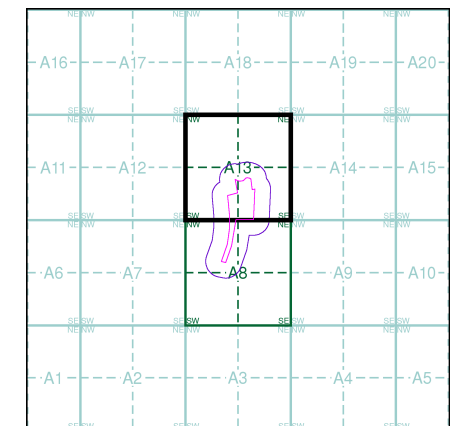

Order Details

Order Number: 41914630_1_1
 Customer Ref: 12044
 National Grid Reference: 331690, 189280
 Slice: A
 Site Area (Ha): 4.52
 Search Buffer (m): 100

Site Details

., Herbert Road, NEWPORT, Gwent, NP19 7BH



Tel: 0844 844 9952
 Fax: 0844 844 9951
 Web: www.envirocheck.co.uk

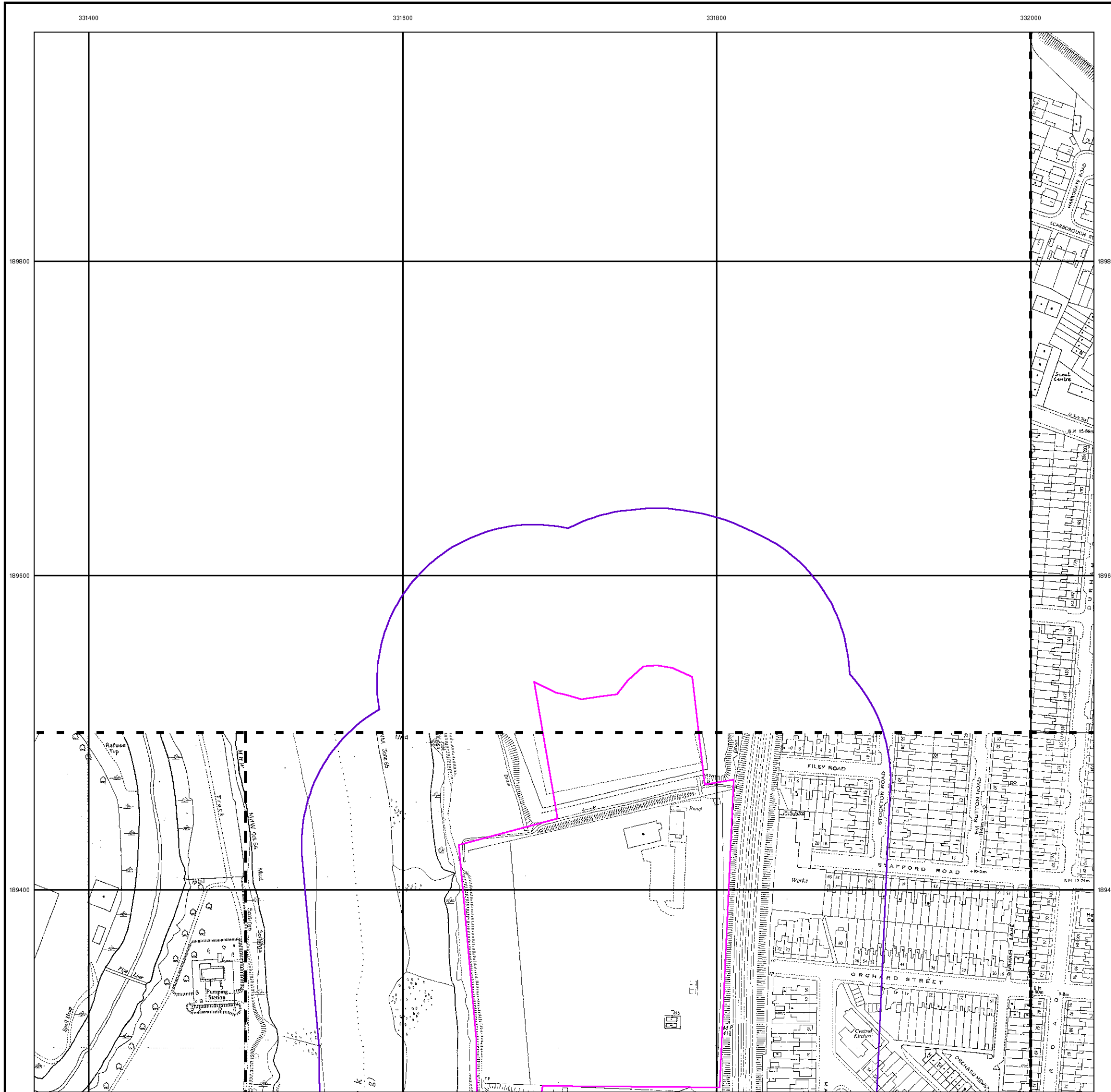

331400

331600

331800

332000

189800

189800

189600

189600

189400

189400

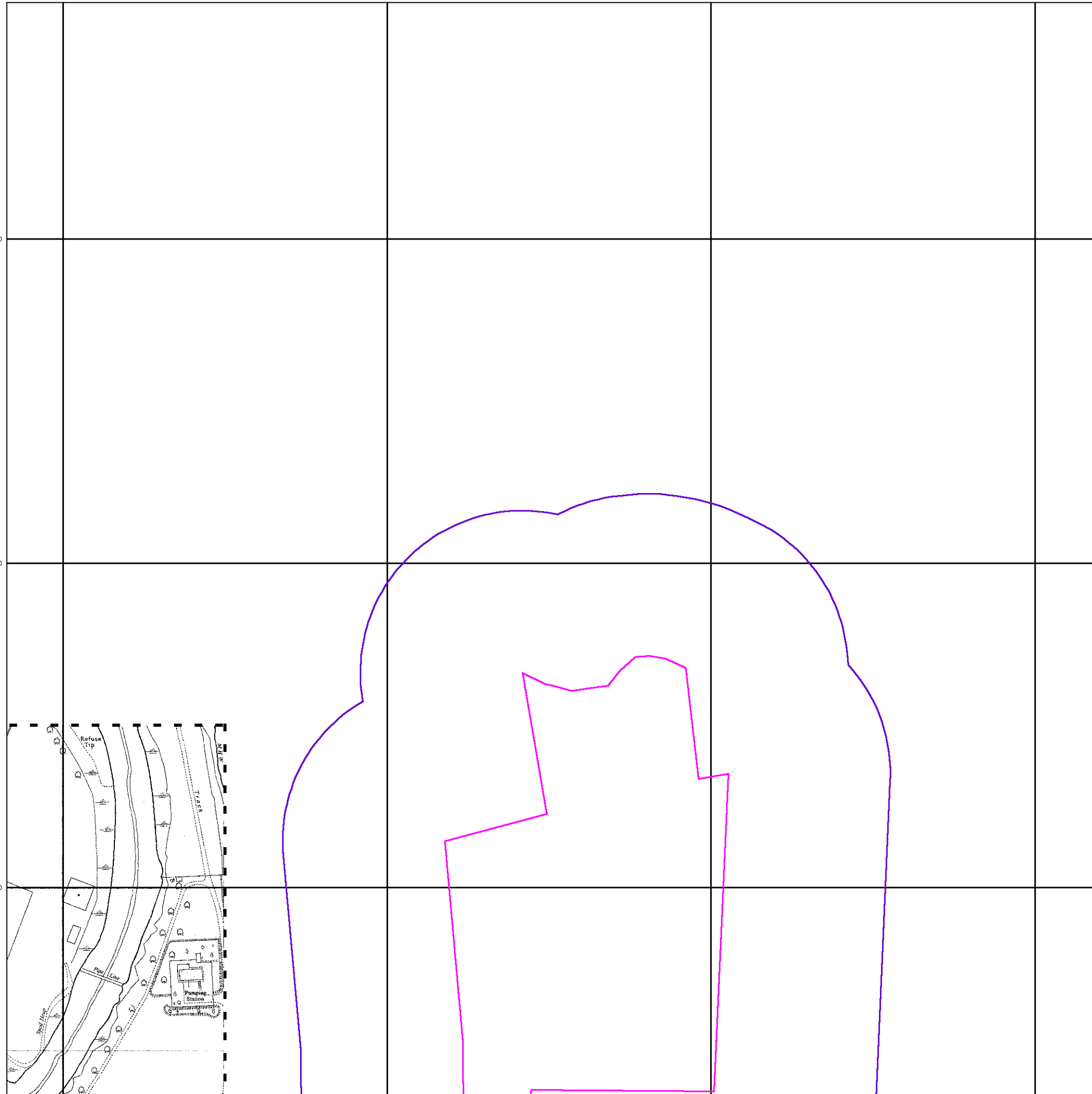

© Crown copyright and Landmark Information Group Limited 2012. All Rights Reserved.

0 100 m



Additional SIMs

Published 1989

Source map scale - 1:1,250

The SIM cards (Ordnance Survey's 'Survey of Information on Microfilm') are further, minor editions of mapping which were produced and published in between the main editions as an area was updated. They date from 1947 to 1994, and contain detailed information on buildings, roads and land-use. These maps were produced at both 1:2,500 and 1:1,250 scales.

Map Name(s) and Date(s)

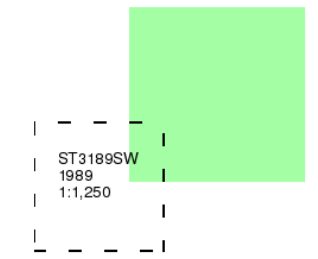

Historical Map - Segment A13

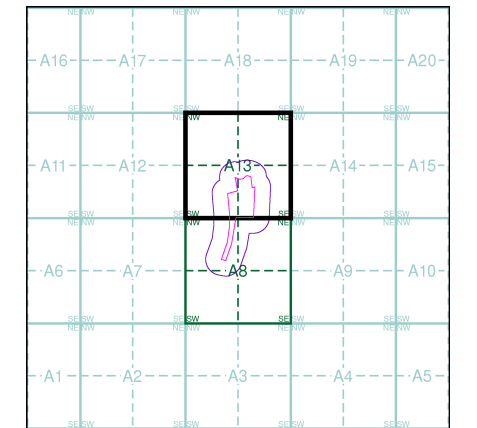

Order Details

Order Number: 41914630_1_1
 Customer Ref: 12044
 National Grid Reference: 331690, 189280
 Slice: A
 Site Area (Ha): 4.52
 Search Buffer (m): 100

Site Details

., Herbert Road, NEWPORT, Gwent, NP19 7BH



Tel: 0844 844 9952
 Fax: 0844 844 9951
 Web: www.envirocheck.co.uk



Large-Scale National Grid Data

Published 1993

Source map scale - 1:1,250

'Large Scale National Grid Data' superseded SIM cards (Ordnance Survey's 'Survey of Information on Microfilm') in 1992, and continued to be produced until 1999. These maps were the fore-runners of digital mapping and so provide detailed information on houses and roads, but tend to show less topographic features such as vegetation. These maps were produced at both 1:2,500 and 1:1,250 scales.

Map Name(s) and Date(s)

| | | |
|------------------------------|------------------------------|------------------------------|
| ST3 189NW 1993 1:1,250 | ST3 189NE 1993 1:1,250 | ST3 289NW 1993 1:1,250 |
| ST3 189SW 1993 1:1,250 | ST3 189SE 1993 1:1,250 | ST3 289SW 1993 1:1,250 |

Historical Map - Segment A13

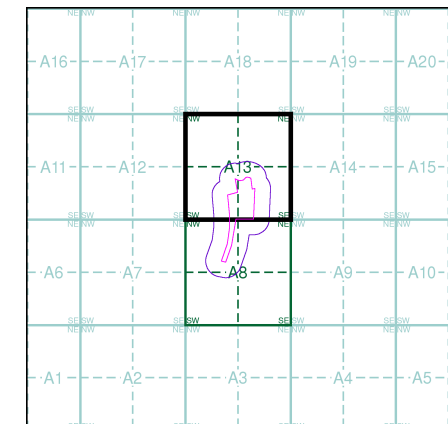

Order Details

Order Number: 41914630_1_1
 Customer Ref: 12044
 National Grid Reference: 331690, 189280
 Slice: A
 Site Area (Ha): 4.52
 Search Buffer (m): 100

Site Details

., Herbert Road, NEWPORT, Gwent, NP19 7BH



Tel: 0844 844 9952
 Fax: 0844 844 9951
 Web: www.envirocheck.co.uk

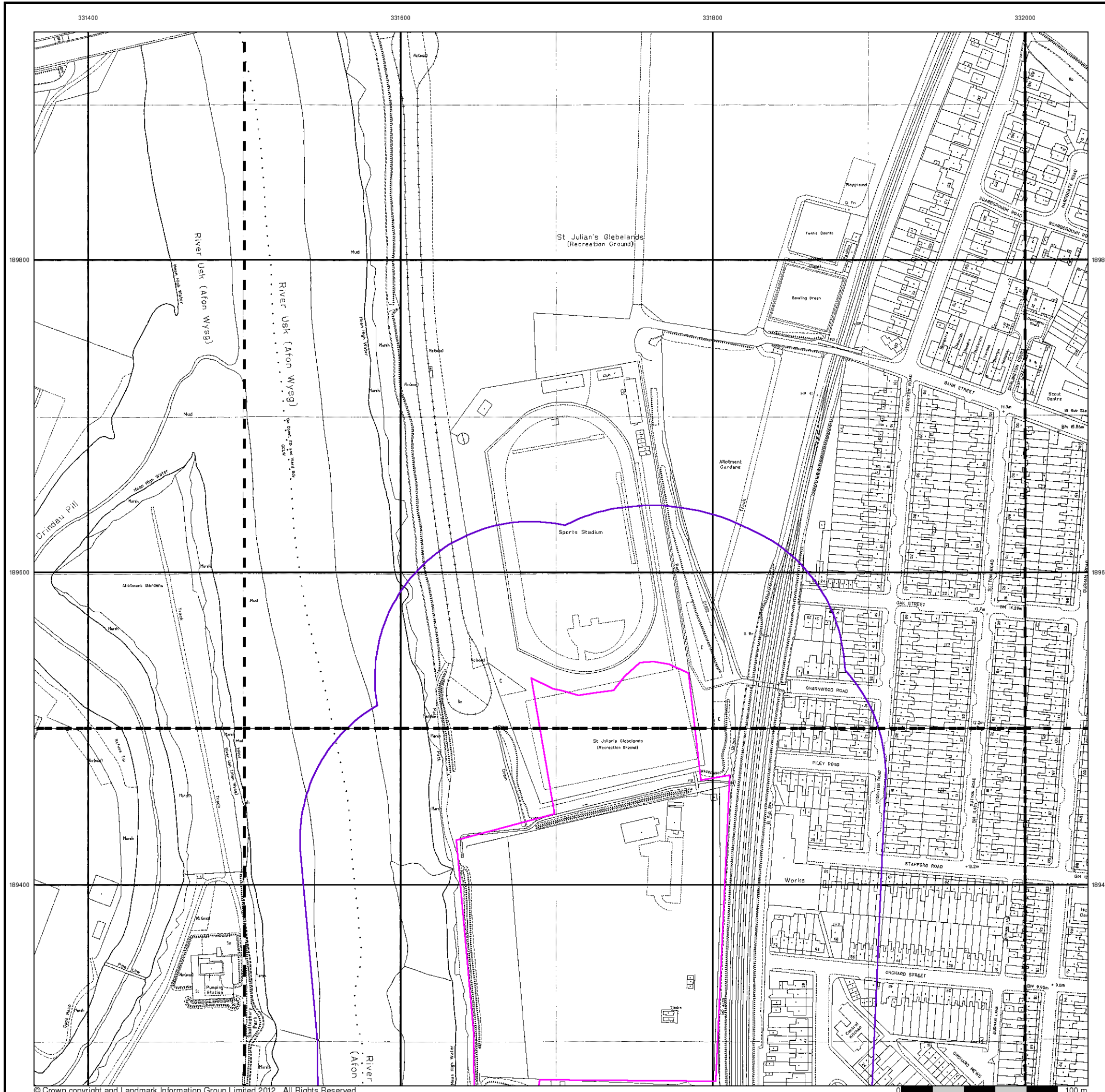



Large-Scale National Grid Data

Published 1994 - 1995

Source map scale - 1:1,250

'Large Scale National Grid Data' superseded SIM cards (Ordnance Survey's 'Survey of Information on Microfilm') in 1992, and continued to be produced until 1999. These maps were the fore-runners of digital mapping and so provide detailed information on houses and roads, but tend to show less topographic features such as vegetation. These maps were produced at both 1:2,500 and 1:1,250 scales.

Map Name(s) and Date(s)

| | | |
|------------------------------|------------------------------|------------------------------|
| ST3 189NW 1994 1:1,250 | ST3 189NE 1995 1:1,250 | ST3 289NW 1995 1:1,250 |
| ST3 189SW 1994 1:1,250 | ST3 189SE 1994 1:1,250 | |

Historical Map - Segment A13

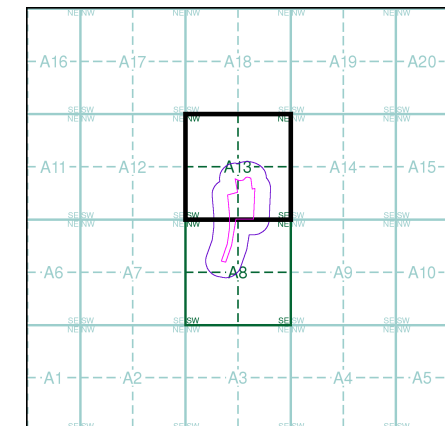

Order Details

Order Number: 41914630_1_1
 Customer Ref: 12044
 National Grid Reference: 331690, 189280
 Slice: A
 Site Area (Ha): 4.52
 Search Buffer (m): 100

Site Details

., Herbert Road, NEWPORT, Gwent, NP19 7BH



Tel: 0844 844 9952
 Fax: 0844 844 9951
 Web: www.envirocheck.co.uk

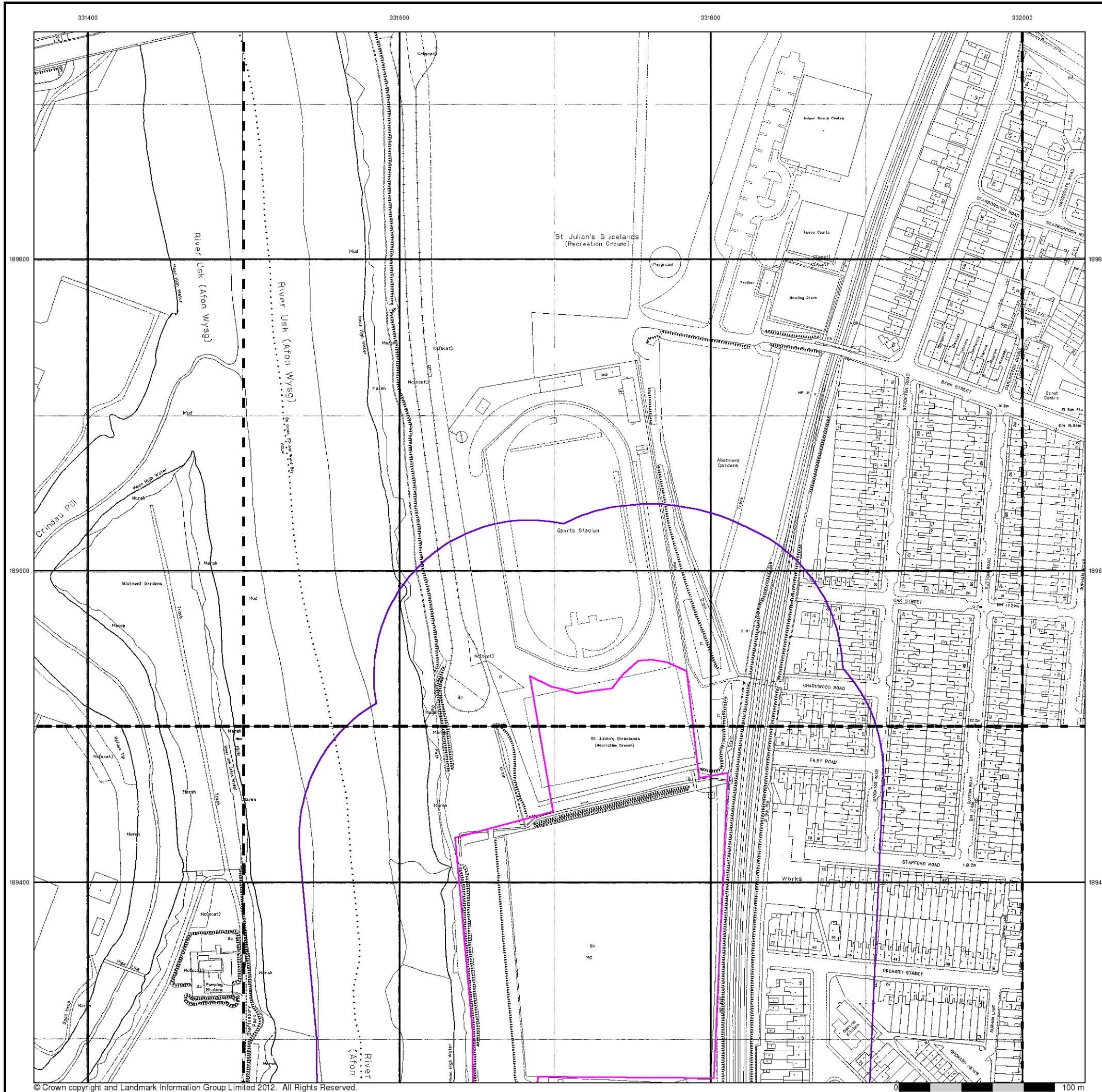



Large-Scale National Grid Data

Published 1995 - 1997

Source map scale - 1:1,250

'Large Scale National Grid Data' superseded SIM cards (Ordnance Survey's 'Survey of Information on Microfilm') in 1992, and continued to be produced until 1999. These maps were the fore-runners of digital mapping and so provide detailed information on houses and roads, but tend to show less topographic features such as vegetation. These maps were produced at both 1:2,500 and 1:1,250 scales.

Map Name(s) and Date(s)

| | |
|-----------------------------|-----------------------------|
| ST3189NW 1995 1:1,250 | ST3189NE 1995 1:1,250 |
| ST3189SW 1997 1:1,250 | |

Historical Map - Segment A13

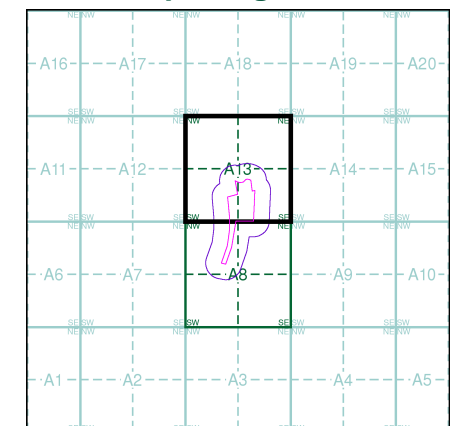

Order Details

Order Number: 41914630_1_1
 Customer Ref: 12044
 National Grid Reference: 331690, 189280
 Slice: A
 Site Area (Ha): 4.52
 Search Buffer (m): 100

Site Details

., Herbert Road, NEWPORT, Gwent, NP19 7BH



Tel: 0844 844 9952
 Fax: 0844 844 9951
 Web: www.envirocheck.co.uk

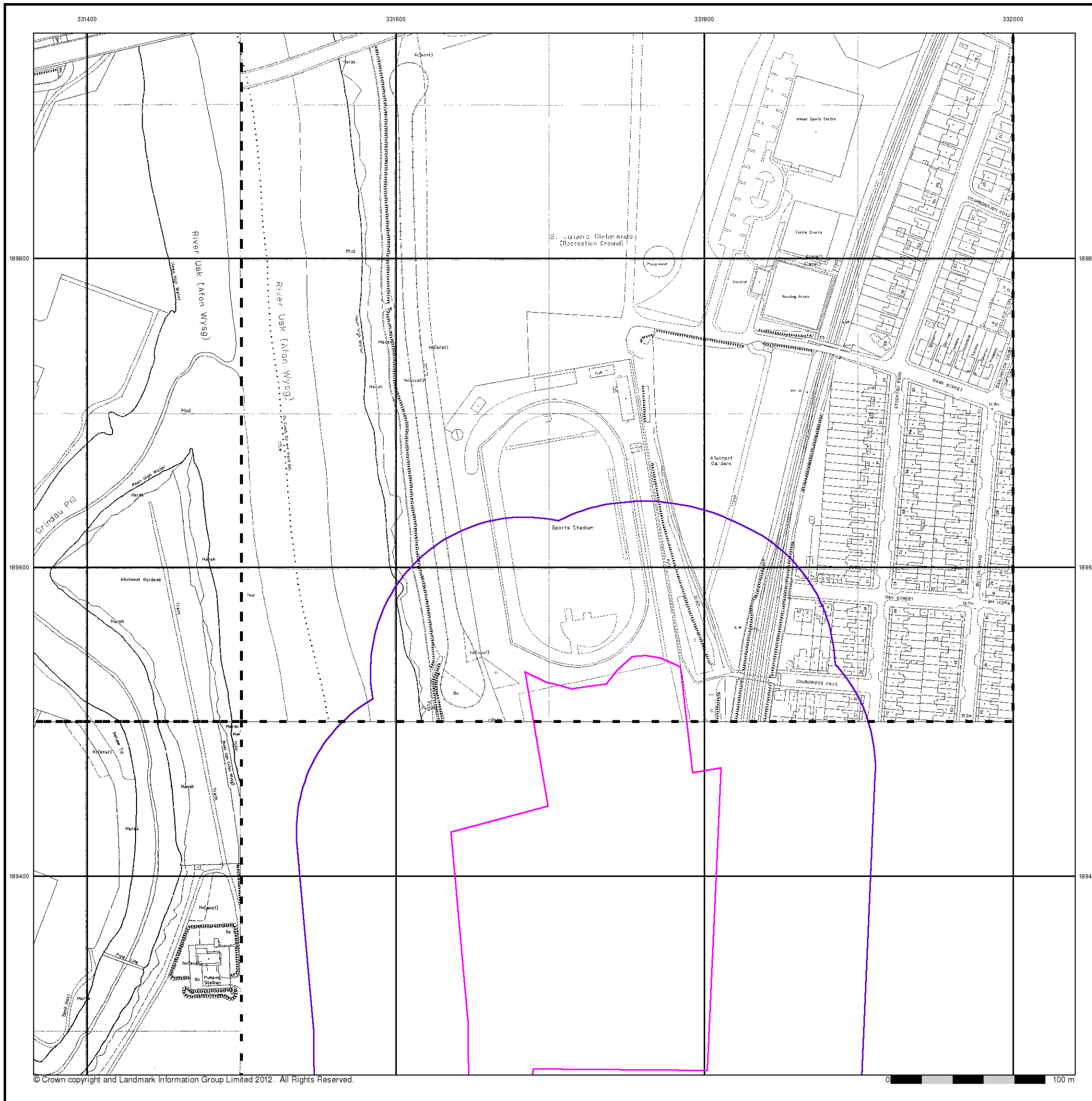



Large-Scale National Grid Data

Published 1995

Source map scale - 1:1,250

'Large Scale National Grid Data' superseded SIM cards (Ordnance Survey's 'Survey of Information on Microfilm') in 1992, and continued to be produced until 1999. These maps were the fore-runners of digital mapping and so provide detailed information on houses and roads, but tend to show less topographic features such as vegetation. These maps were produced at both 1:2,500 and 1:1,250 scales.

Map Name(s) and Date(s)

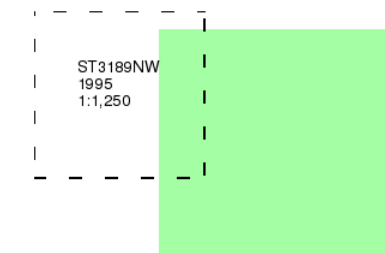

Historical Map - Segment A13

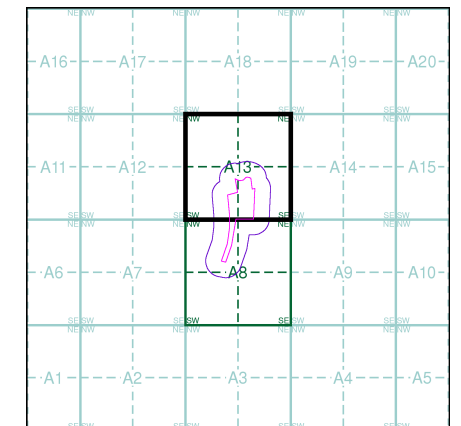

Order Details

Order Number: 41914630_1_1
Customer Ref: 12044
National Grid Reference: 331690, 189280
Slice: A
Site Area (Ha): 4.52
Search Buffer (m): 100

Site Details

., Herbert Road, NEWPORT, Gwent, NP19 7BH



Tel: 0844 844 9952
Fax: 0844 844 9951
Web: www.envirocheck.co.uk

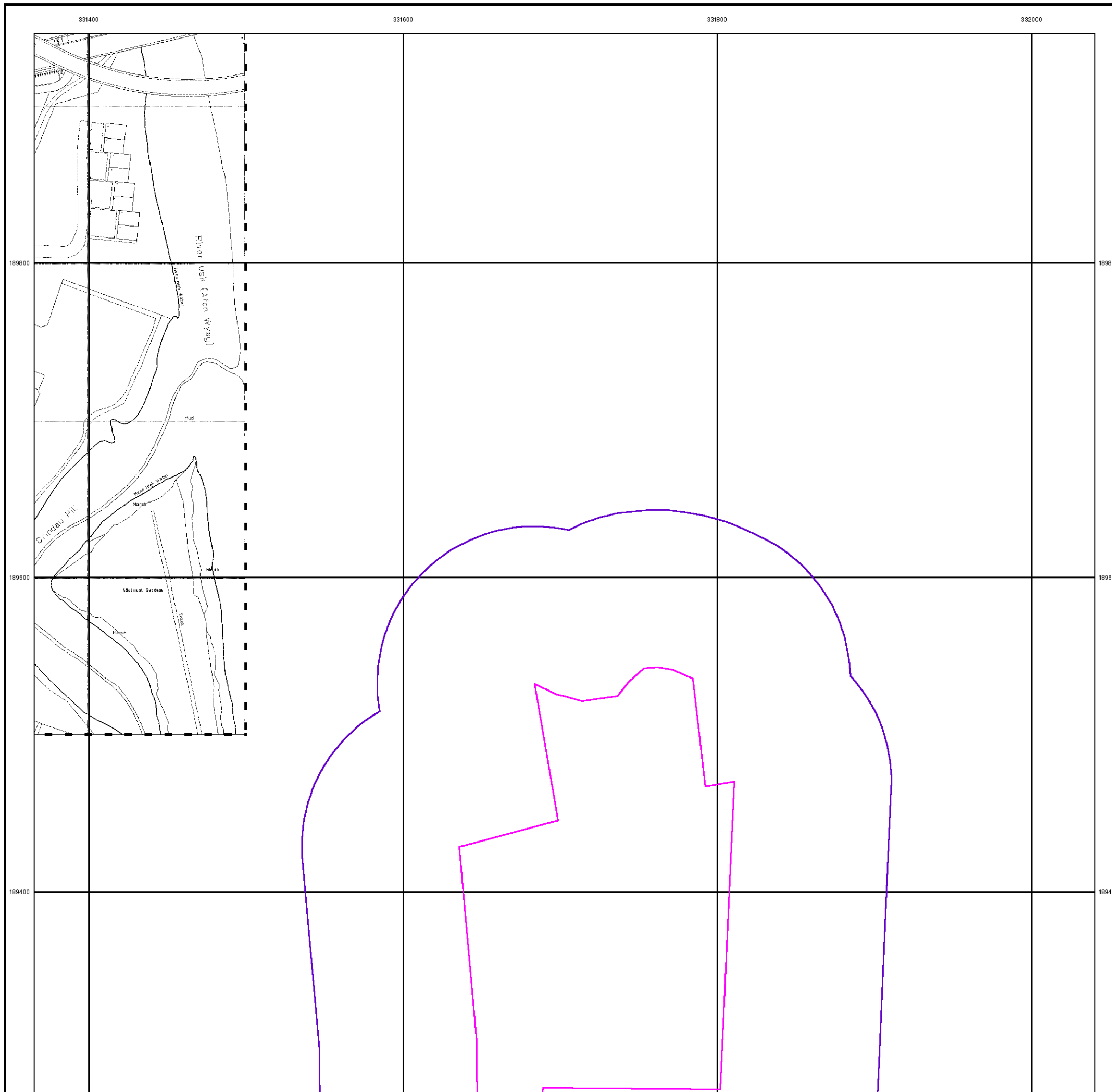

Historical Mapping Legends

Ordnance Survey County Series and Ordnance Survey Plan 1:2,500

Quarry **Gravel Pit** **Sand Pit**
Clay Pit **Shingle** **Refuse Heap**
Sloping Masonry **Flat Rock**

Marsh **Reeds** **Osiers**
Rough Pasture **Furze** **Wood**
Mixed Wood **Brushwood** **Orchard**

Fir **Ford** **Stepping Stones**
Ferry **Waterfall** **Lock**

Trig. Station **Altitude at Trig. Station**
B.M. 325.9 **Bench Mark** **Surface Level**
Arrow denotes flow of water **Antiquities (site of)**

Cutting **Embankment**

Railway crossing Road **Level Crossing** **Road crossing Railway**
Railway crossing River or Canal **Road over single stream** **Road over River or Canal**

----- County Boundary (Geographical)
 - - - - - County & Civil Parish Boundary
 + + + + + Administrative County & Civil Parish Boundary
 - - - - - County Borough Boundary (England)
 Co. Boro. Bdy.
 - - - - - County Burgh Boundary (Scotland)
 Co. Burgh Bdy.

B.P. B.S. Boundary Post or Stone **P.C.B.** Police Call Box
B.R. Bridle Road **P** Pump
E.P. Electricity Pylon **S.P.** Signal Post
F.B. Foot Bridge **Sl.** Sluice
F.P. Foot Path **Sp.** Spring
G.P. Guide Post or Board **T.C.B.** Telephone Call Box
M.S. Mile Stone **Tr.** Trough
M.P. M.R. Mooring Post or Ring **W** Well

Ordnance Survey Plan, Additional SIMs and Supply of Unpublished Survey Information 1:2,500 and 1:1,250

Inactive Quarry, Chalk Pit or Clay Pit **Active Quarry, Chalk Pit or Clay Pit**
Rock **Boulders**

Roofed Building **Glazed Roof Building**
Sloping Masonry **Archway**

Non-Coniferous Tree (surveyed) **Coniferous Tree (surveyed)**
Non-Coniferous Trees (not surveyed) **Coniferous Trees (not surveyed)**

Orchard Tree **Scrub** **Bracken**
Coppice, Osier **Reeds** **Marsh, Saltings**

Rough Grassland **Heath** **Culvert**
Direction of water flow **Bench Mark** **Antiquity (site of)**

Cave Entrance **Triangulation Station** **Electricity Pylon**

Electricity Transmission Line

----- County Boundary (Geographical)
 - - - - - County & Civil Parish Boundary
 Civil Parish Boundary
 - + - + - Admin. County or County Bor. Boundary
 - L B Bdy - London Borough Boundary
 X X X X X Symbol marking point where boundary mereing changes

BH Beer House **P** Pillar, Pole or Post
BP, BS Boundary Post or Stone **PO** Post Office
Cn, C Capstan, Crane **PC** Public Convenience
Chy Chimney **PH** Public House
D Fn Drinking Fountain **Pp** Pump
EI P Electricity Pillar or Post **SB, S Br** Signal Box or Bridge
FAP Fire Alarm Pillar **SP, SL** Signal Post or Light
FB Foot Bridge **Spr** Spring
GP Guide Post **Tk** Tank or Track
H Hydrant or Hydraulic **TCB** Telephone Call Box
LC Level Crossing **TCP** Telephone Call Post
MH Manhole **Tr** Trough
MP Mile Post or Mooring Post **Wr Pt, Wr T** Water Point, Water Tap
MS Mile Stone **W** Well
NTL Normal Tidal Limit **Wd Pp** Wind Pump

Large-Scale National Grid Data 1:2,500 and 1:1,250

Cliff **Slopes** **Top**

Rock **Rock (scattered)**
Boulders **Boulders (scattered)**
Positioned Boulder **Scree**

Non-Coniferous Tree (surveyed) **Coniferous Tree (surveyed)**
Non-Coniferous Trees (not surveyed) **Coniferous Trees (not surveyed)**

Orchard Tree **Scrub** **Bracken**
Coppice, Osier **Reeds** **Marsh, Saltings**

Rough Grassland **Heath** **Culvert**
Direction of water flow **Triangulation Station** **Antiquity (site of)**

Electricity Transmission Line **Electricity Pylon**

B.M. 231.60m Bench Mark **Buildings with Building Seed**
Roofed Building **Glazed Roof Building**

• • • • • Civil parish/community boundary
 - - - - - District boundary
 - . - - - County boundary
 o Boundary post/stone
 Boundary mereing symbol (note: these always appear in opposed pairs or groups of three)

Bks Barracks **P** Pillar, Pole or Post
Bty Battery **PO** Post Office
Cemy Cemetery **PC** Public Convenience
Chy Chimney **Pp** Pump
Cis Cistern **Ppg Sta** Pumping Station
Dismtd Rly Dismantled Railway **PW** Place of Worship
EI Gen Sta Electricity Generating Station **Sewage Ppg Sta** Sewage Pumping Station

EI P Electricity Pole, Pillar **SB, S Br** Signal Box or Bridge
EI Sub Sta Electricity Sub Station **SP, SL** Signal Post or Light
FB Filter Bed **Spr** Spring
Fn / D Fn Fountain / Drinking Ftn. **Tk** Tank or Track
Gas Gov Gas Valve Compound **Tr** Trough
GVC Gas Governor **Wd Pp** Wind Pump
GP Guide Post **Wr Pt, Wr T** Water Point, Water Tap
MH Manhole **Wks** Works (building or area)
MP, MS Mile Post or Mile Stone **W** Well



Historical Mapping & Photography included:

| Mapping Type | Scale | Date | Pg |
|--|---------|-------------|----|
| Monmouthshire | 1:2,500 | 1883 | 2 |
| Monmouthshire | 1:2,500 | 1902 | 3 |
| Monmouthshire | 1:2,500 | 1920 | 4 |
| Monmouthshire | 1:2,500 | 1937 | 5 |
| Ordnance Survey Plan | 1:1,250 | 1955 - 1957 | 6 |
| Ordnance Survey Plan | 1:2,500 | 1955 - 1957 | 7 |
| Additional SIMs | 1:1,250 | 1957 - 1992 | 8 |
| Ordnance Survey Plan | 1:1,250 | 1966 - 1976 | 9 |
| Ordnance Survey Plan | 1:2,500 | 1969 - 1970 | 10 |
| Supply of Unpublished Survey Information | 1:1,250 | 1974 | 11 |
| Additional SIMs | 1:1,250 | 1978 - 1991 | 12 |
| Additional SIMs | 1:1,250 | 1989 | 13 |
| Large-Scale National Grid Data | 1:1,250 | 1993 | 14 |
| Large-Scale National Grid Data | 1:1,250 | 1994 - 1997 | 15 |
| Large-Scale National Grid Data | 1:1,250 | 1997 | 16 |

Historical Map - Segment A8

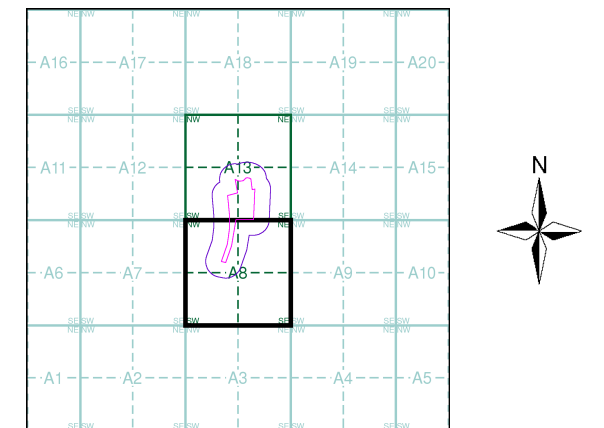

Order Details

Order Number: 41914630_1_1
 Customer Ref: 12044
 National Grid Reference: 331690, 189280
 Slice: A
 Site Area (Ha): 4.52
 Search Buffer (m): 100

Site Details

., Herbert Road, NEWPORT, Gwent, NP19 7BH



Tel: 0844 844 9952
 Fax: 0844 844 9951
 Web: www.envirocheck.co.uk

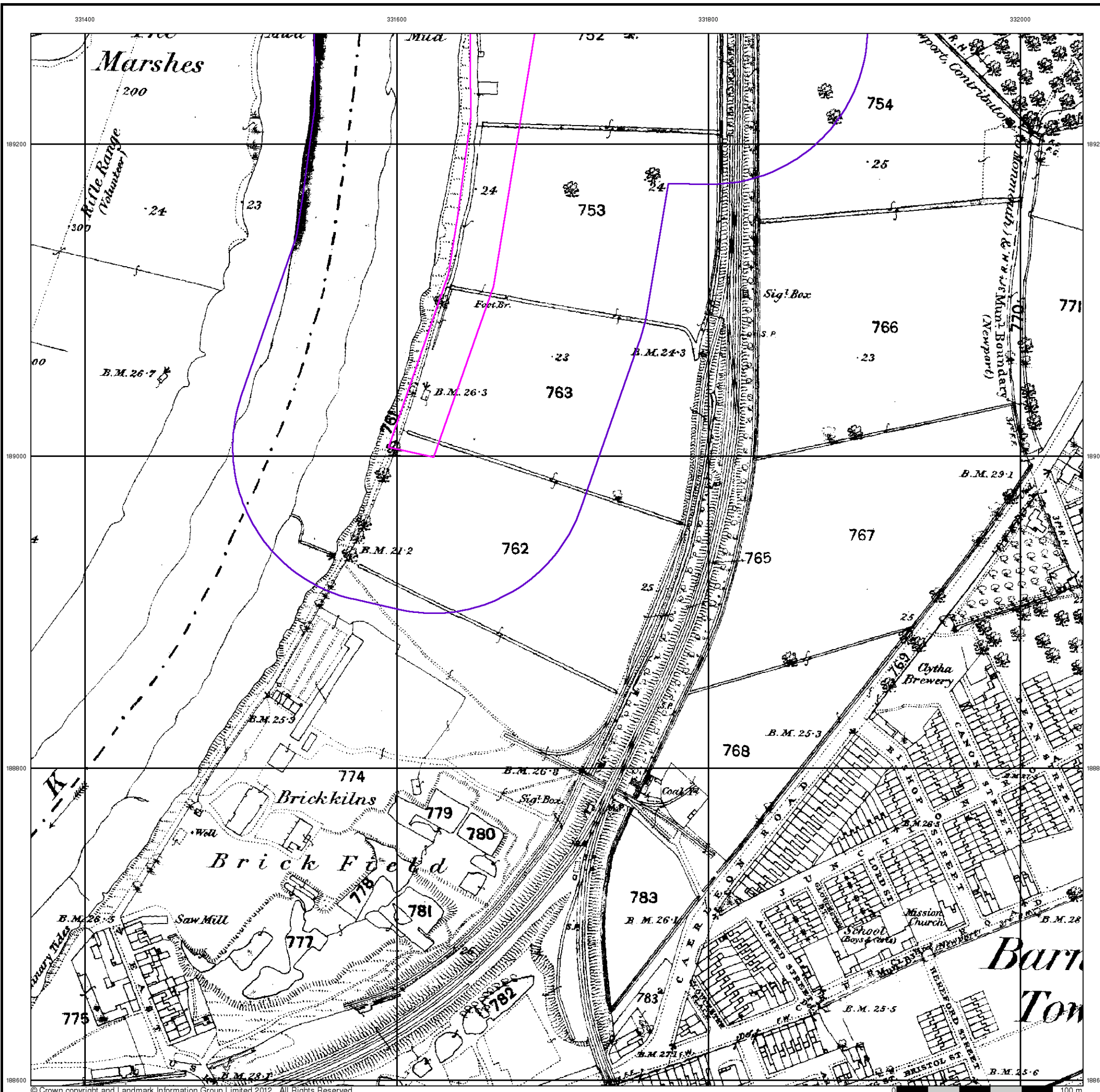

Monmouthshire
Published 1883
Source map scale - 1:2,500

The historical maps shown were reproduced from maps predominantly held at the scale adopted for England, Wales and Scotland in the 1840's. In 1854 the 1:2,500 scale was adopted for mapping urban areas and by 1896 it covered the whole of what were considered to be the cultivated parts of Great Britain. The published date given below is often some years later than the surveyed date. Before 1938, all OS maps were based on the Cassini Projection, with independent surveys of a single county or group of counties, giving rise to significant inaccuracies in outlying areas.

Map Name(s) and Date(s)

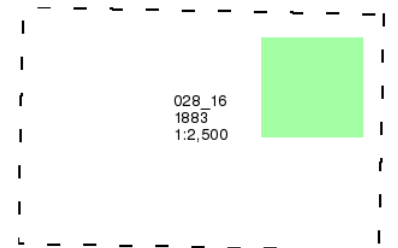

Historical Map - Segment A8

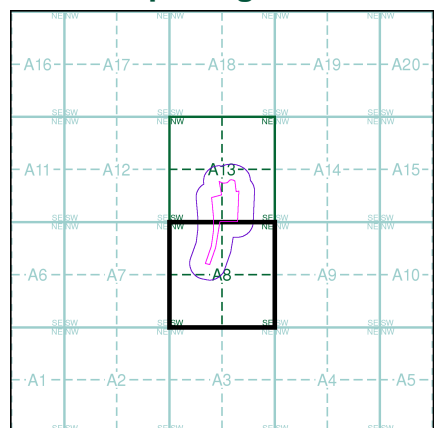

Order Details
 Order Number: 41914630_1_1
 Customer Ref: 12044
 National Grid Reference: 331690, 189280
 Slice: A
 Site Area (Ha): 4.52
 Search Buffer (m): 100

Site Details
 ., Herbert Road, NEWPORT, Gwent, NP19 7BH

Landmark Information Group
 Tel: 0844 844 9952
 Fax: 0844 844 9951
 Web: www.envirocheck.co.uk

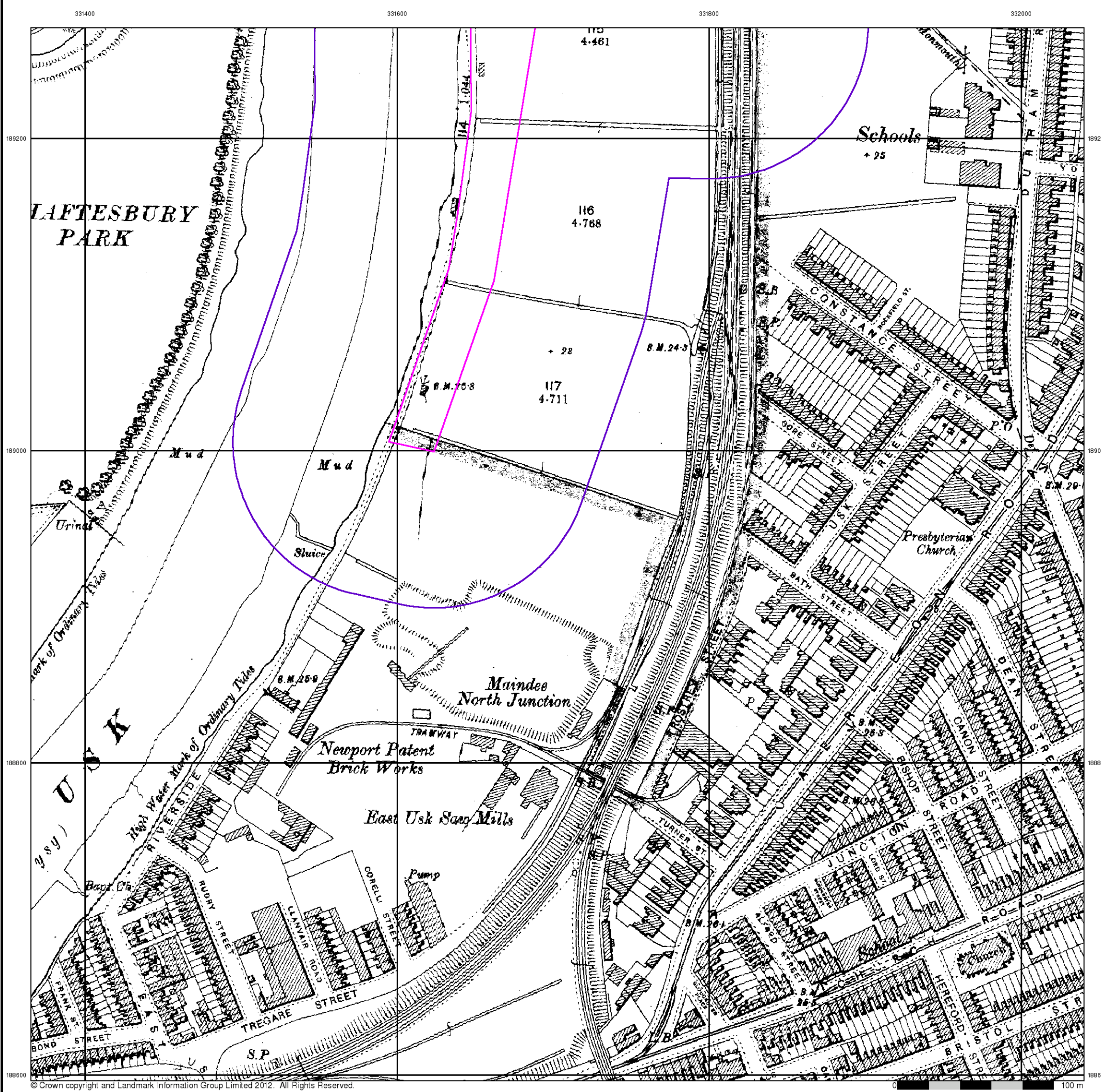

Monmouthshire
Published 1902
Source map scale - 1:2,500

The historical maps shown were reproduced from maps predominantly held at the scale adopted for England, Wales and Scotland in the 1840's. In 1854 the 1:2,500 scale was adopted for mapping urban areas and by 1896 it covered the whole of what were considered to be the cultivated parts of Great Britain. The published date given below is often some years later than the surveyed date. Before 1938, all OS maps were based on the Cassini Projection, with independent surveys of a single county or group of counties, giving rise to significant inaccuracies in outlying areas.

Map Name(s) and Date(s)

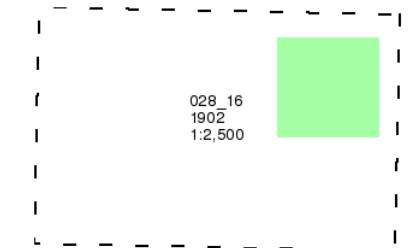

Historical Map - Segment A8

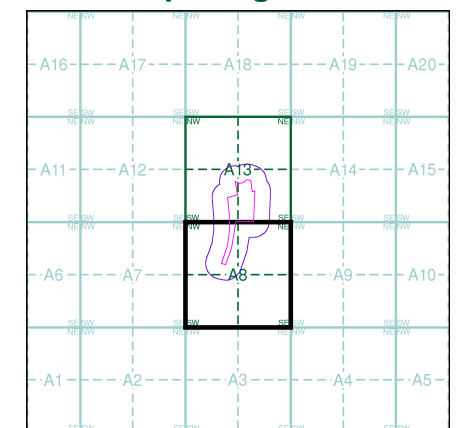

Order Details

Order Number: 41914630_1_1
 Customer Ref: 12044
 National Grid Reference: 331690, 189280
 Slice: A
 Site Area (Ha): 4.52
 Search Buffer (m): 100

Site Details

Herbert Road, NEWPORT, Gwent, NP19 7BH



Tel: 0844 844 9952
 Fax: 0844 844 9951
 Web: www.envirocheck.co.uk

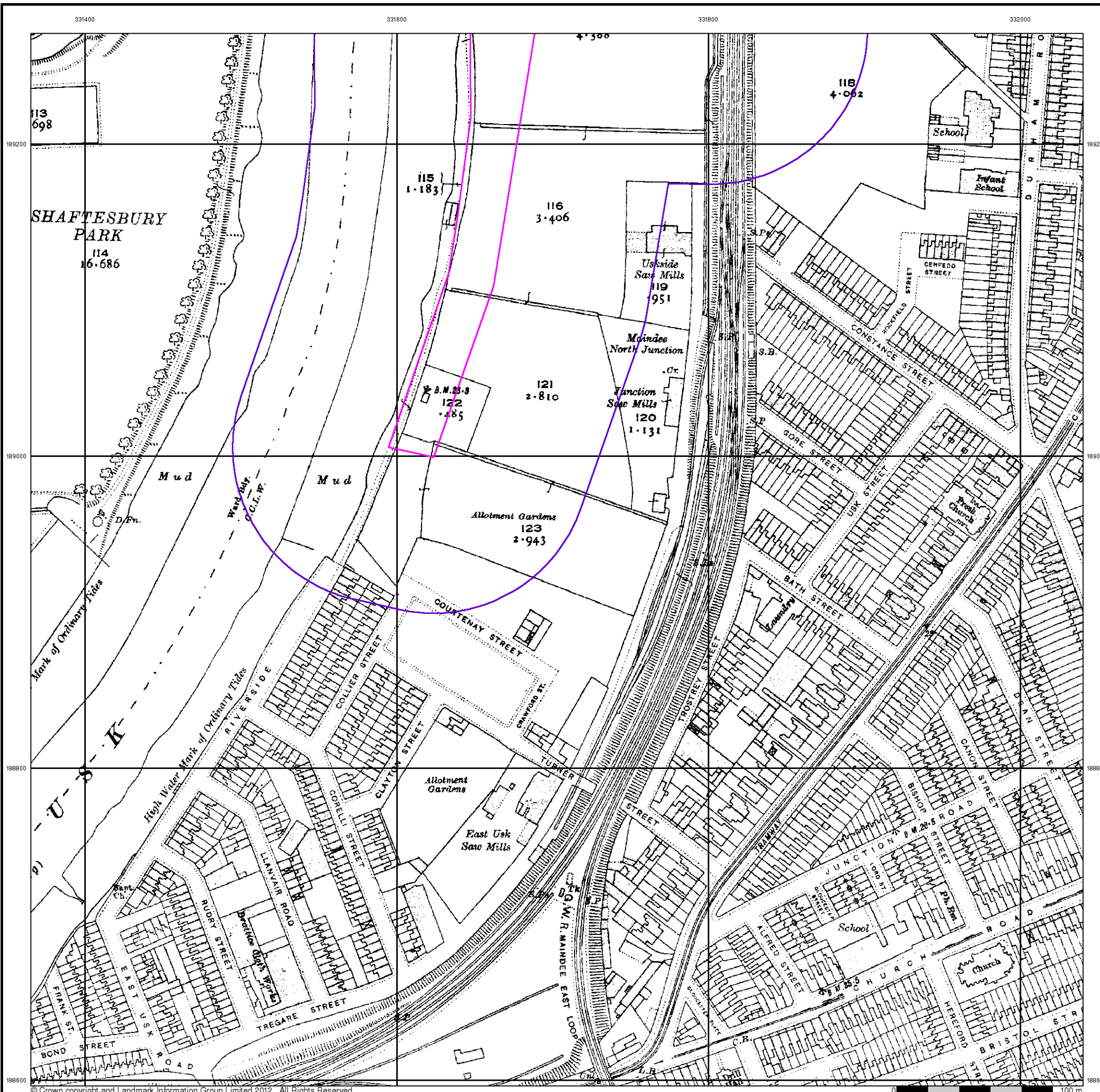

Monmouthshire
Published 1920
Source map scale - 1:2,500

The historical maps shown were reproduced from maps predominantly held at the scale adopted for England, Wales and Scotland in the 1840's. In 1854 the 1:2,500 scale was adopted for mapping urban areas and by 1896 it covered the whole of what were considered to be the cultivated parts of Great Britain. The published date given below is often some years later than the surveyed date. Before 1938, all OS maps were based on the Cassini Projection, with independent surveys of a single county or group of counties, giving rise to significant inaccuracies in outlying areas.

Map Name(s) and Date(s)

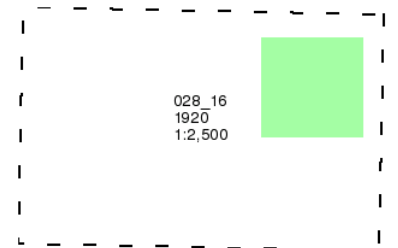

Historical Map - Segment A8

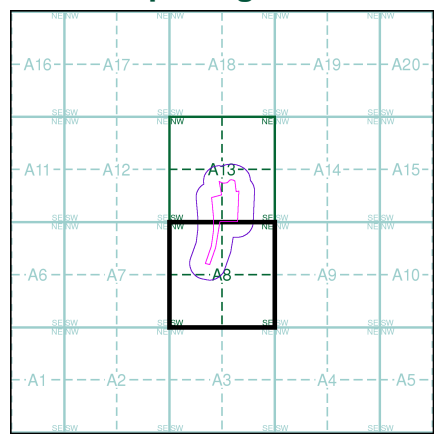

Order Details
 Order Number: 41914630_1_1
 Customer Ref: 12044
 National Grid Reference: 331690, 189280
 Slice: A
 Site Area (Ha): 4.52
 Search Buffer (m): 100

Site Details
 ., Herbert Road, NEWPORT, Gwent, NP19 7BH

Landmark
 Information Group
 Tel: 0844 844 9952
 Fax: 0844 844 9951
 Web: www.envirocheck.co.uk

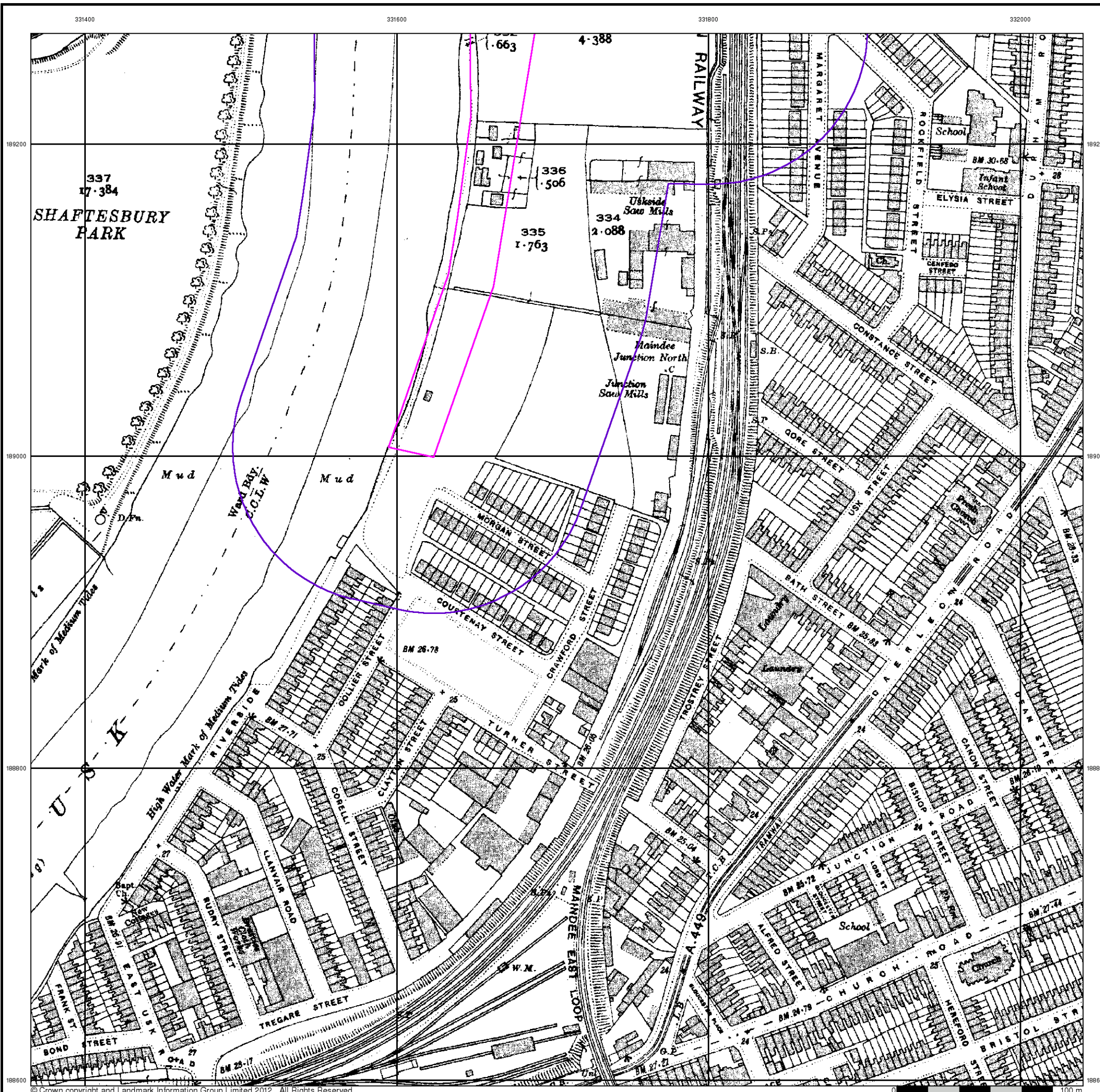

Monmouthshire
Published 1937
Source map scale - 1:2,500

The historical maps shown were reproduced from maps predominantly held at the scale adopted for England, Wales and Scotland in the 1840's. In 1854 the 1:2,500 scale was adopted for mapping urban areas and by 1896 it covered the whole of what were considered to be the cultivated parts of Great Britain. The published date given below is often some years later than the surveyed date. Before 1938, all OS maps were based on the Cassini Projection, with independent surveys of a single county or group of counties, giving rise to significant inaccuracies in outlying areas.

Map Name(s) and Date(s)

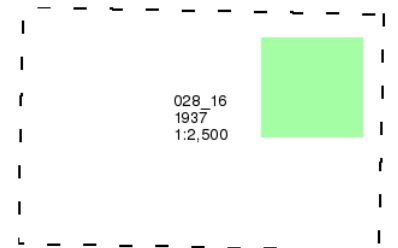

Historical Map - Segment A8

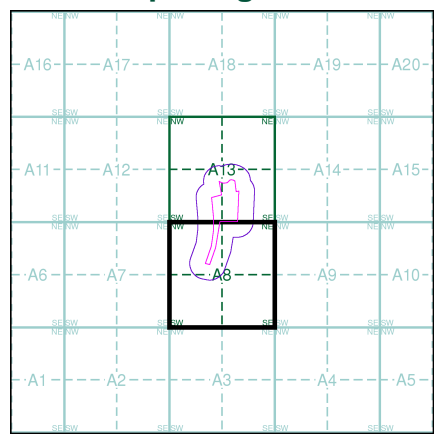

Order Details

| | |
|--------------------------|----------------|
| Order Number: | 41914630_1_1 |
| Customer Ref: | 12044 |
| National Grid Reference: | 331690, 189280 |
| Slice: | A |
| Site Area (Ha): | 4.52 |
| Search Buffer (m): | 100 |

Site Details
 ., Herbert Road, NEWPORT, Gwent, NP19 7BH



Ordnance Survey Plan

Published 1955 - 1957

Source map scale - 1:1,250

The historical maps shown were reproduced from maps predominantly held at the scale adopted for England, Wales and Scotland in the 1840's. In 1854 the 1:2,500 scale was adopted for mapping urban areas and by 1896 it covered the whole of what were considered to be the cultivated parts of Great Britain. The published date given below is often some years later than the surveyed date. Before 1938, all OS maps were based on the Cassini Projection, with independent surveys of a single county or group of counties, giving rise to significant inaccuracies in outlying areas.

Map Name(s) and Date(s)

| | | |
|-----------------------------|-----------------------------|-----------------------------|
| ST3189SW 1955 1:1,250 | ST3189SE 1955 1:1,250 | ST3289SW 1957 1:1,250 |
| ST3188NW 1955 1:1,250 | ST3188NE 1955 1:1,250 | ST3288NW 1956 1:1,250 |

Historical Map - Segment A8

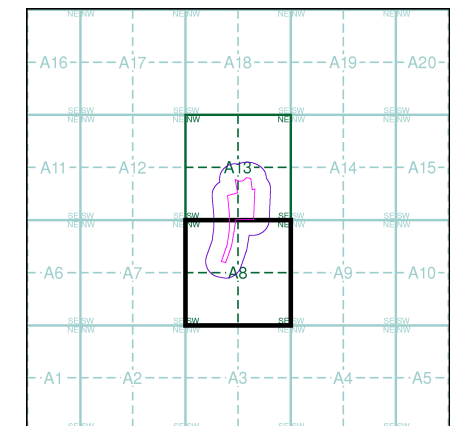

Order Details

Order Number: 41914630_1_1
 Customer Ref: 12044
 National Grid Reference: 331690, 189280
 Slice: A
 Site Area (Ha): 4.52
 Search Buffer (m): 100

Site Details

Herbert Road, NEWPORT, Gwent, NP19 7BH



Tel: 0844 844 9952
 Fax: 0844 844 9951
 Web: www.envirocheck.co.uk

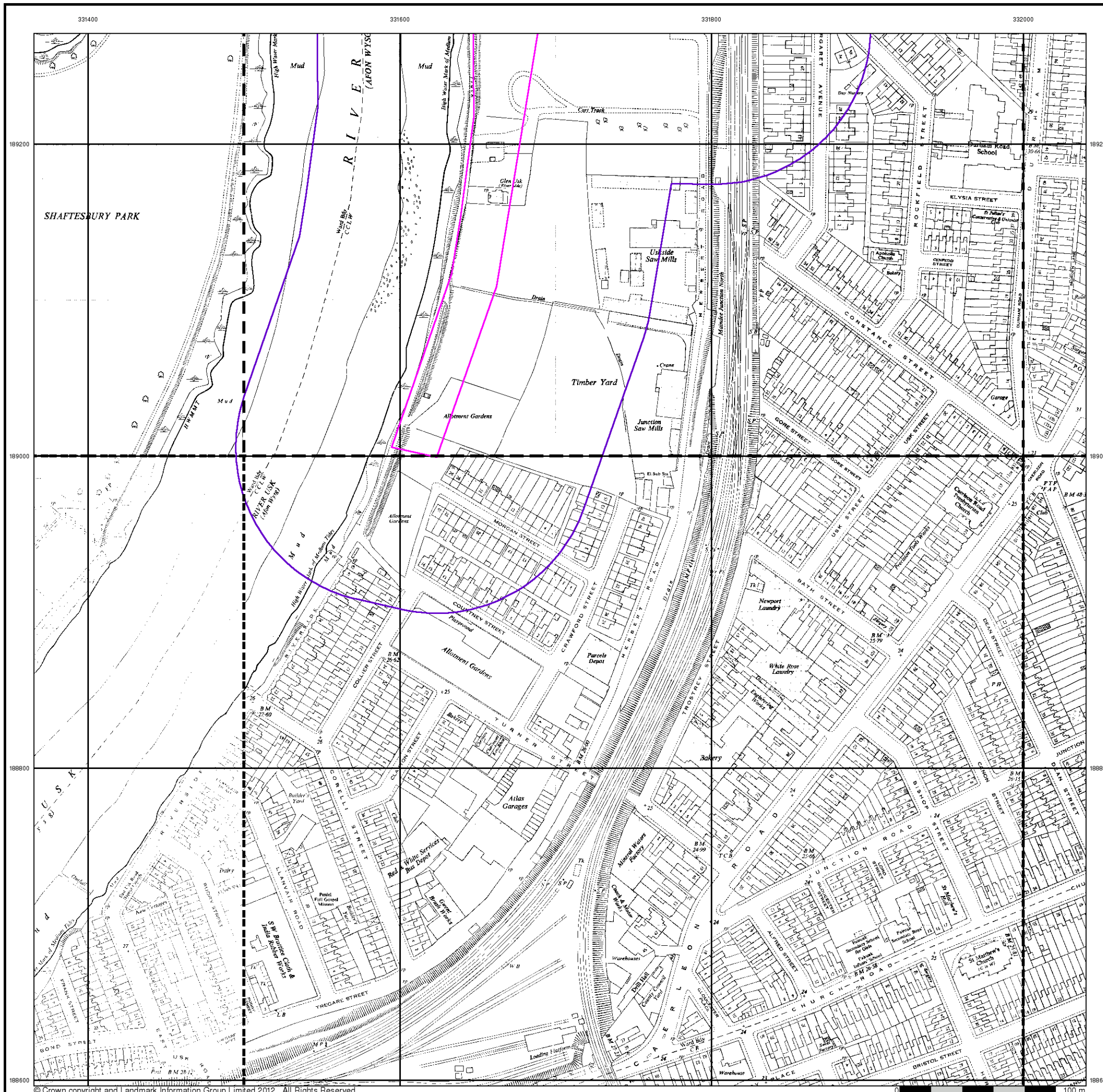



Ordnance Survey Plan

Published 1955 - 1957

Source map scale - 1:2,500

The historical maps shown were reproduced from maps predominantly held at the scale adopted for England, Wales and Scotland in the 1840's. In 1854 the 1:2,500 scale was adopted for mapping urban areas and by 1896 it covered the whole of what were considered to be the cultivated parts of Great Britain. The published date given below is often some years later than the surveyed date. Before 1938, all OS maps were based on the Cassini Projection, with independent surveys of a single county or group of counties, giving rise to significant inaccuracies in outlying areas.

Map Name(s) and Date(s)

| | |
|--------------------------|--------------------------|
| ST3189 1955 12,500 | ST3289 1957 12,500 |
| ST3188 1956 12,500 | ST3288 1956 12,500 |

Historical Map - Segment A8

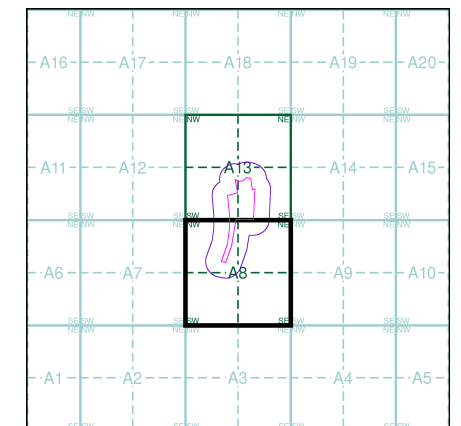

Order Details

Order Number: 41914630_1_1
 Customer Ref: 12044
 National Grid Reference: 331690, 189280
 Slice: A
 Site Area (Ha): 4.52
 Search Buffer (m): 100

Site Details

Herbert Road, NEWPORT, Gwent, NP19 7BH



Tel: 0844 844 9952
 Fax: 0844 844 9951
 Web: www.envirocheck.co.uk

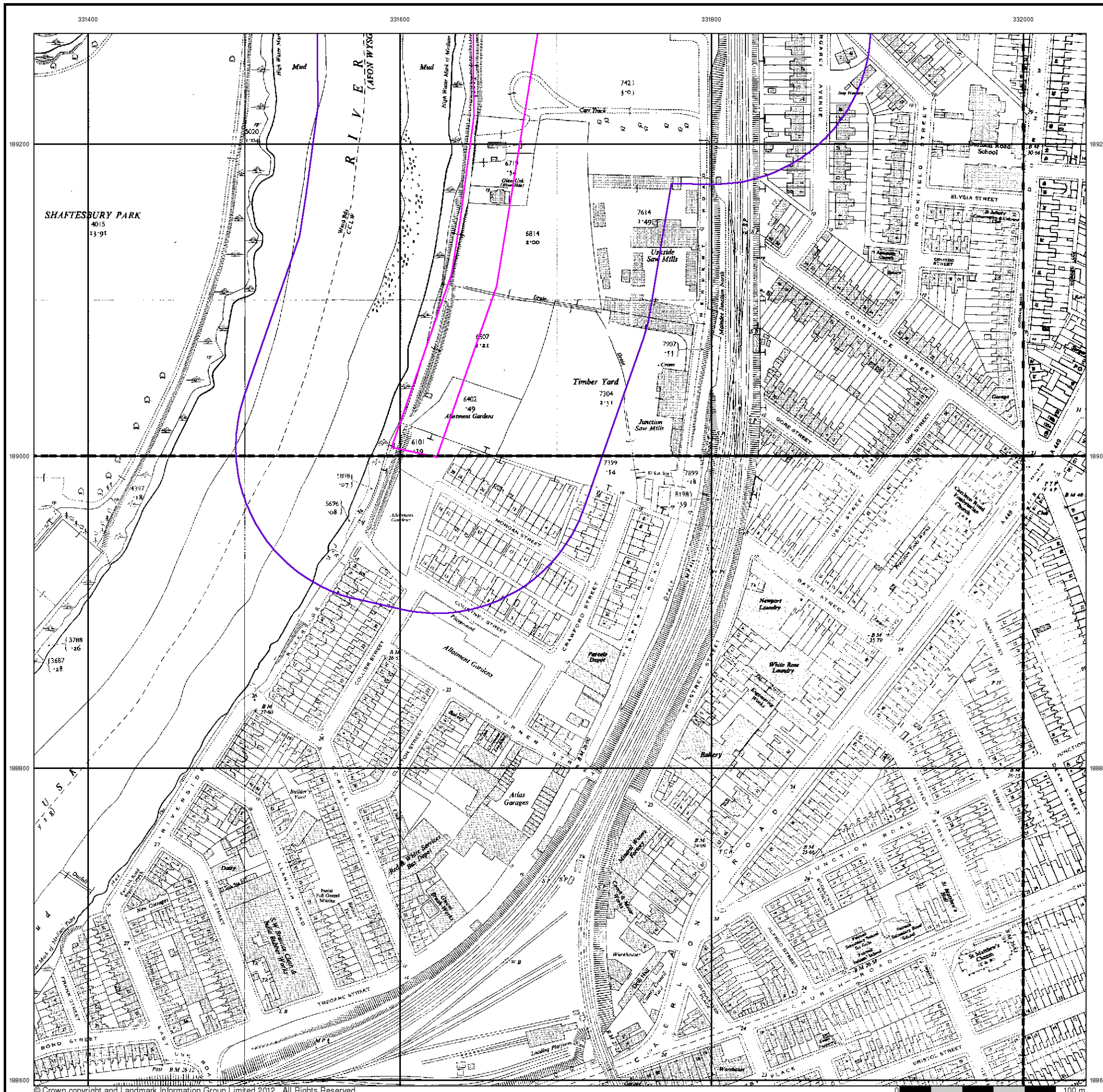



Additional SIMs

Published 1957 - 1992

Source map scale - 1:1,250

The SIM cards (Ordnance Survey's 'Survey of Information on Microfilm') are further, minor editions of mapping which were produced and published in between the main editions as an area was updated. They date from 1947 to 1994, and contain detailed information on buildings, roads and land-use. These maps were produced at both 1:2,500 and 1:1,250 scales.

Map Name(s) and Date(s)

| | | |
|-----------------------------|-----------------------------|-----------------------------|
| ST3189SW 1982 1:1,250 | ST3189SE 1978 1:1,250 | ST3289SW 1957 1:1,250 |
| ST3188NW 1982 1:1,250 | ST3188NE 1992 1:1,250 | ST3288NW 1990 1:1,250 |

Historical Map - Segment A8

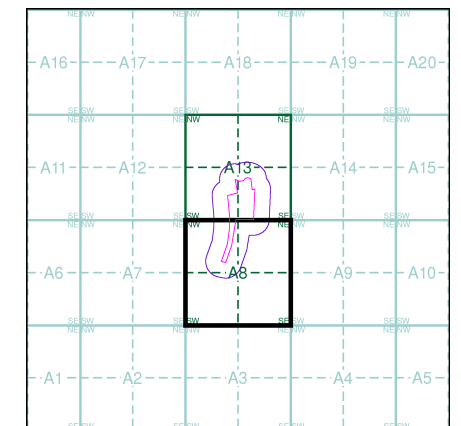

Order Details

Order Number: 41914630_1_1
 Customer Ref: 12044
 National Grid Reference: 331690, 189280
 Slice: A
 Site Area (Ha): 4.52
 Search Buffer (m): 100

Site Details

Herbert Road, NEWPORT, Gwent, NP19 7BH



Tel: 0844 844 9952
 Fax: 0844 844 9951
 Web: www.envirocheck.co.uk

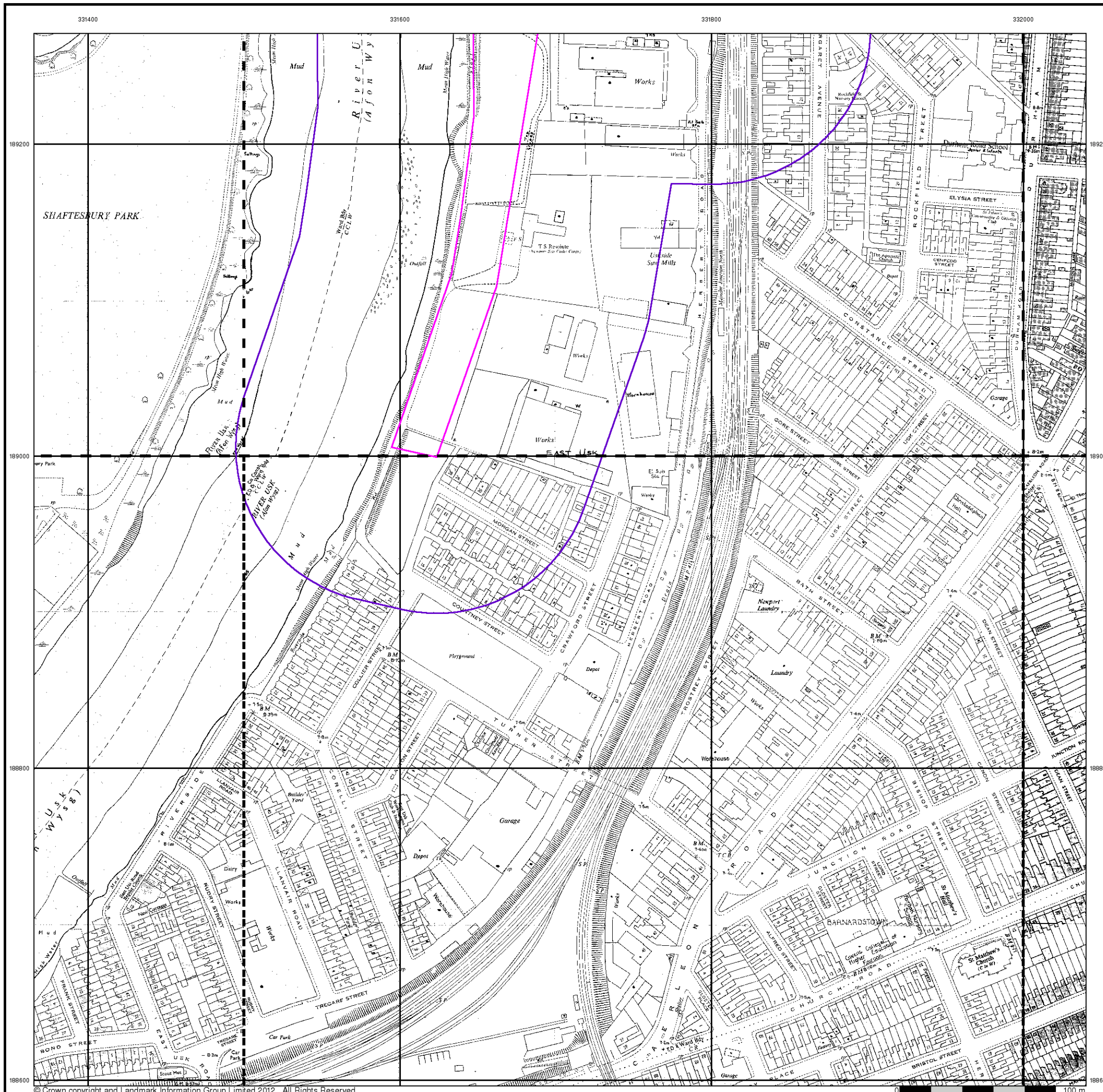



Ordnance Survey Plan

Published 1966 - 1976

Source map scale - 1:1,250

The historical maps shown were reproduced from maps predominantly held at the scale adopted for England, Wales and Scotland in the 1840's. In 1854 the 1:2,500 scale was adopted for mapping urban areas and by 1896 it covered the whole of what were considered to be the cultivated parts of Great Britain. The published date given below is often some years later than the surveyed date. Before 1938, all OS maps were based on the Cassini Projection, with independent surveys of a single county or group of counties, giving rise to significant inaccuracies in outlying areas.

Map Name(s) and Date(s)

| | | |
|------------------------------|------------------------------|------------------------------|
| ST3 189SW 1967 1:1,250 | ST3 189SE 1966 1:1,250 | |
| ST3 188NW 1976 1:1,250 | ST3 188NE 1966 1:1,250 | ST3 288NW 1974 1:1,250 |

Historical Map - Segment A8

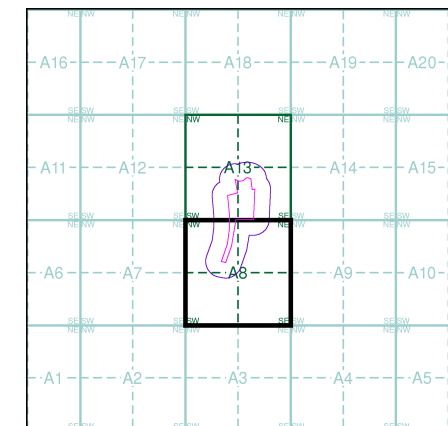

Order Details

Order Number: 41914630_1_1
 Customer Ref: 12044
 National Grid Reference: 331690, 189280
 Slice: A
 Site Area (Ha): 4.52
 Search Buffer (m): 100

Site Details

Herbert Road, NEWPORT, Gwent, NP19 7BH



Tel: 0844 844 9952
 Fax: 0844 844 9951
 Web: www.envirocheck.co.uk

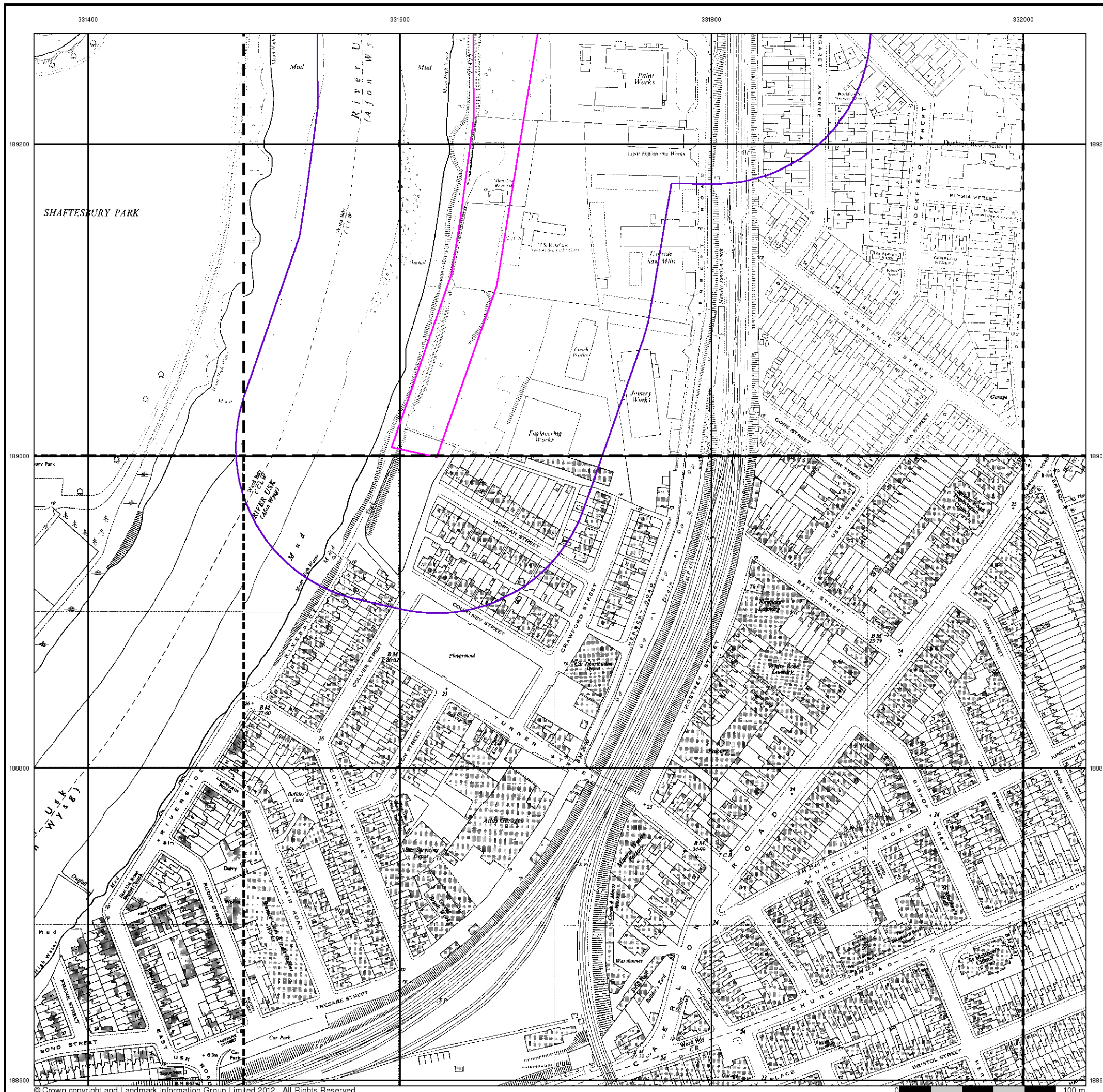

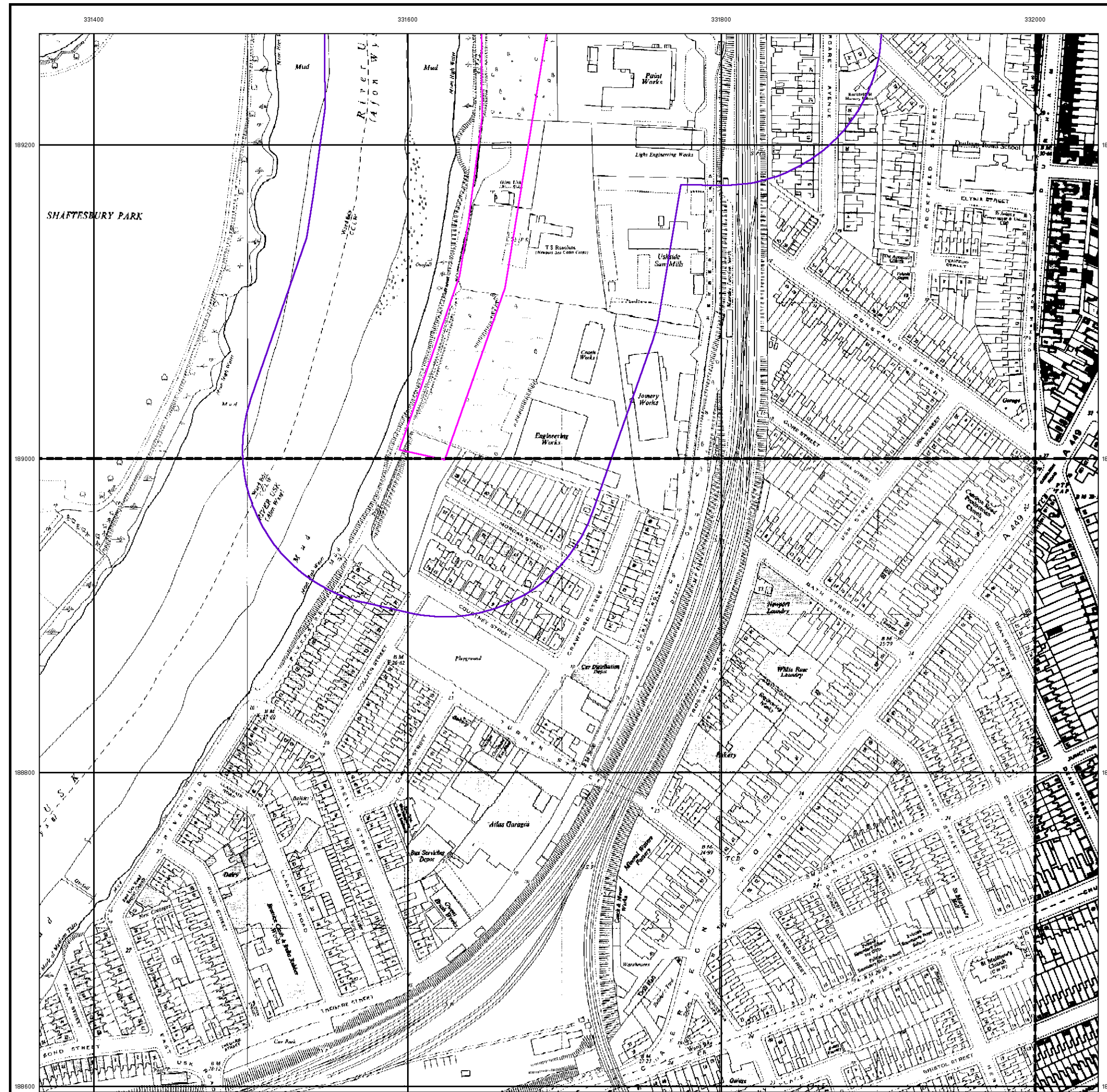

© Crown copyright and Landmark Information Group Limited 2012. All Rights Reserved.



Ordnance Survey Plan
Published 1969 - 1970
Source map scale - 1:2,500

The historical maps shown were reproduced from maps predominantly held at the scale adopted for England, Wales and Scotland in the 1840's. In 1854 the 1:2,500 scale was adopted for mapping urban areas and by 1896 it covered the whole of what were considered to be the cultivated parts of Great Britain. The published date given below is often some years later than the surveyed date. Before 1938, all OS maps were based on the Cassini Projection, with independent surveys of a single county or group of counties, giving rise to significant inaccuracies in outlying areas.

Map Name(s) and Date(s)

| | |
|--------------------------|--------------------------|
| ST3189 1970 12,500 | ST3289 1969 12,500 |
| ST3188 1970 12,500 | ST3288 1970 12,500 |

Historical Map - Segment A8

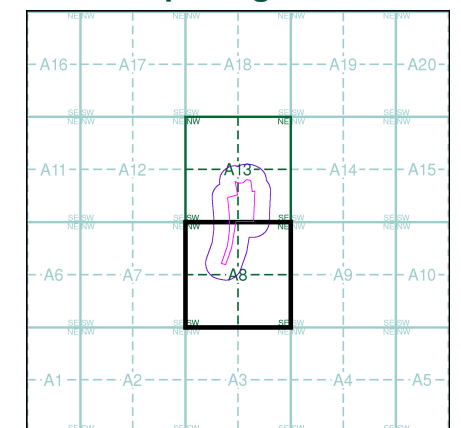

Order Details

Order Number: 41914630_1_1
 Customer Ref: 12044
 National Grid Reference: 331690, 189280
 Slice: A
 Site Area (Ha): 4.52
 Search Buffer (m): 100

Site Details

Herbert Road, NEWPORT, Gwent, NP19 7BH



Tel: 0844 844 9952
 Fax: 0844 844 9951
 Web: www.envirocheck.co.uk



Supply of Unpublished Survey Information

Published 1974

Source map scale - 1:1,250

SUSI maps (Supply of Unpublished Survey Information) were produced between 1972 and 1977, mainly for internal use at Ordnance Survey. These were more of a 'work-in-progress' plan as they showed updates of individual areas on a map. These maps were unpublished, and they do not represent a single moment in time. They were produced at both 1:2,500 and 1:1,250 scales.

Map Name(s) and Date(s)

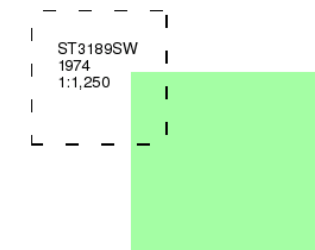

Historical Map - Segment A8

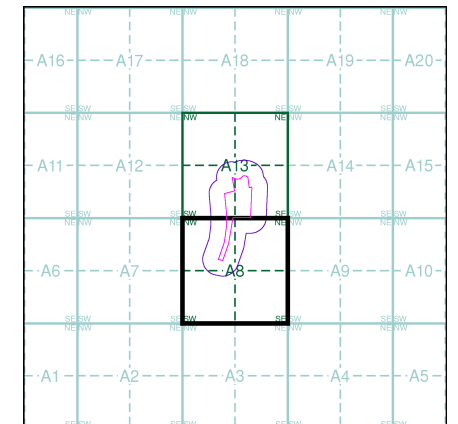

Order Details

Order Number: 41914630_1_1
Customer Ref: 12044
National Grid Reference: 331690, 189280
Slice: A
Site Area (Ha): 4.52
Search Buffer (m): 100

Site Details

., Herbert Road, NEWPORT, Gwent, NP19 7BH



Tel: 0844 844 9952
Fax: 0844 844 9951
Web: www.envirocheck.co.uk

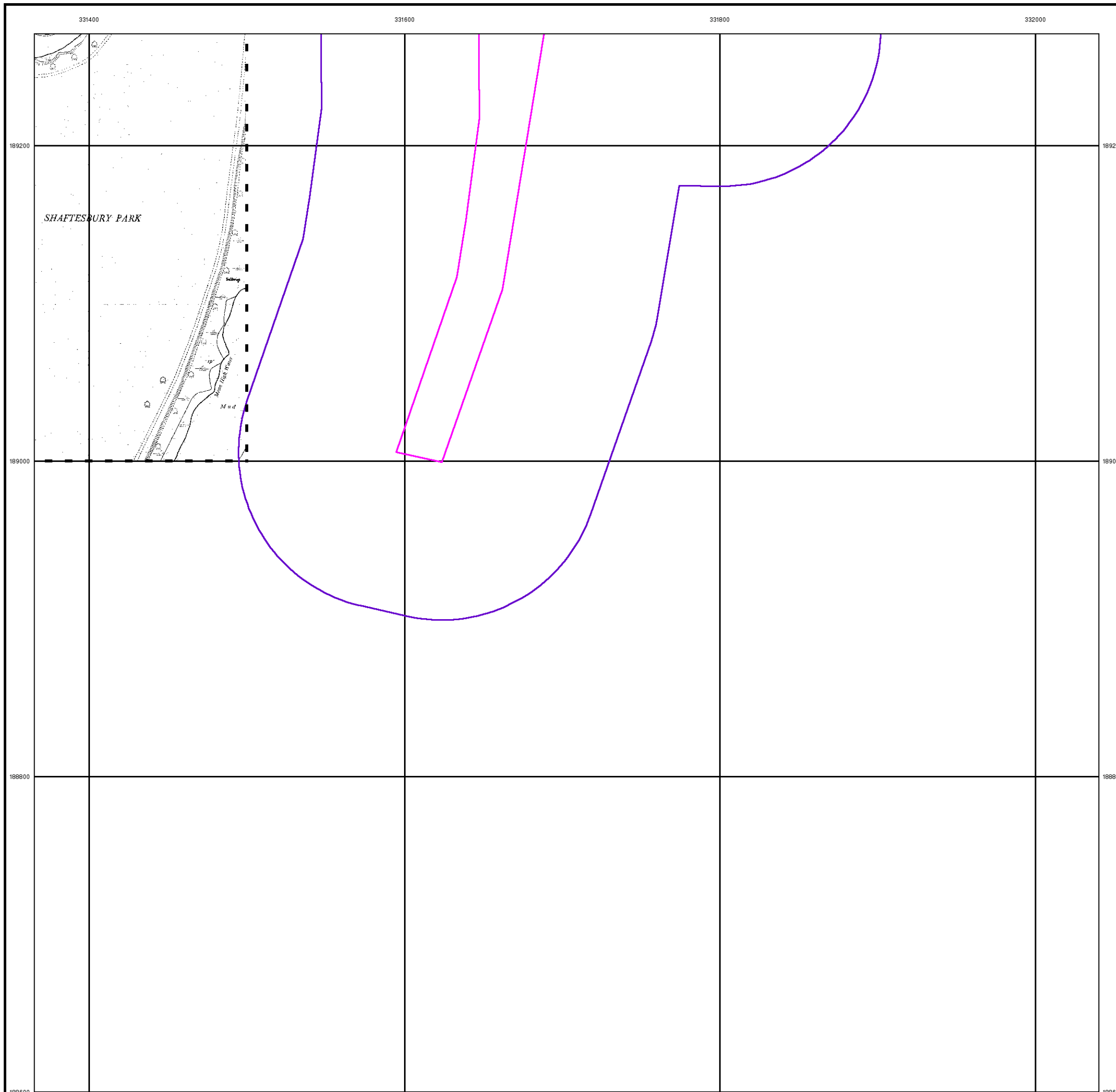

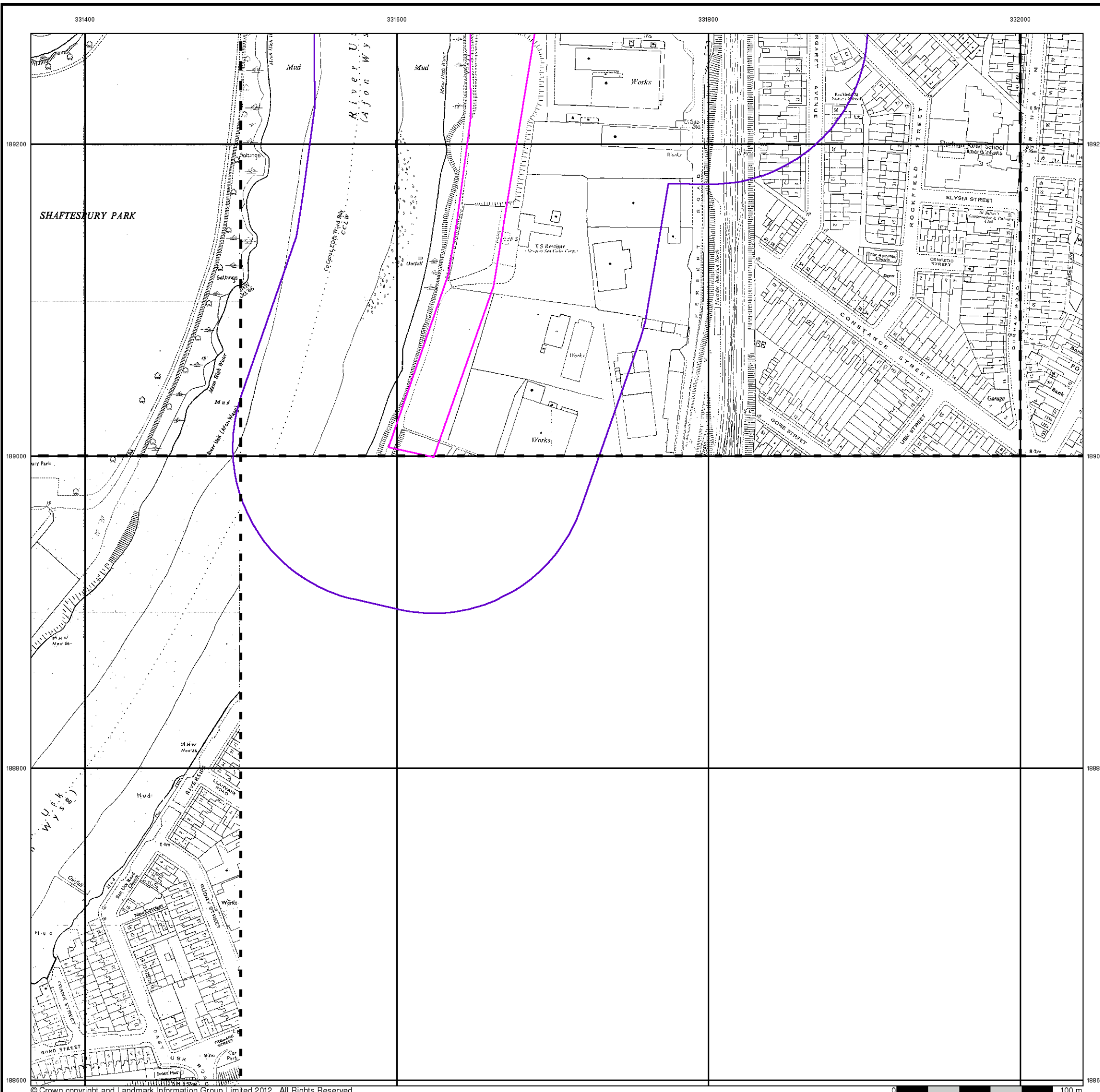

**Additional SIMs
Published 1978 - 1991
Source map scale - 1:1,250**

The SIM cards (Ordnance Survey's 'Survey of Information on Microfilm') are further, minor editions of mapping which were produced and published in between the main editions as an area was updated. They date from 1947 to 1994, and contain detailed information on buildings, roads and land-use. These maps were produced at both 1:2,500 and 1:1,250 scales.

Map Name(s) and Date(s)

| | | |
|------------------------------|------------------------------|------------------------------|
| ST3 189SW 1987 1:1,250 | ST3 189SE 1987 1:1,250 | ST3 289SW 1978 1:1,250 |
| [Map Area] | | |
| ST3 188NW 1991 1:1,250 | | |

Historical Map - Segment A8

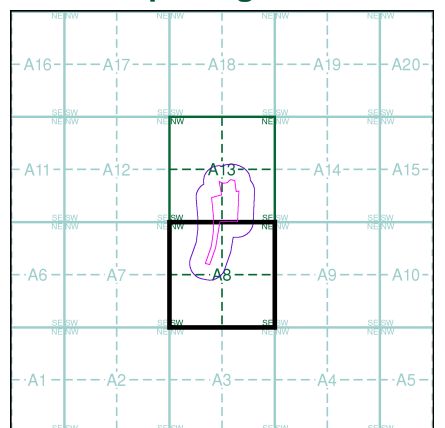

Order Details
 Order Number: 41914630_1_1
 Customer Ref: 12044
 National Grid Reference: 331690, 189280
 Slice: A
 Site Area (Ha): 4.52
 Search Buffer (m): 100

Site Details
 ., Herbert Road, NEWPORT, Gwent, NP19 7BH

Landmark Information Group
 Tel: 0844 844 9952
 Fax: 0844 844 9951
 Web: www.envirocheck.co.uk



Additional SIMs

Published 1989

Source map scale - 1:1,250

The SIM cards (Ordnance Survey's 'Survey of Information on Microfilm') are further, minor editions of mapping which were produced and published in between the main editions as an area was updated. They date from 1947 to 1994, and contain detailed information on buildings, roads and land-use. These maps were produced at both 1:2,500 and 1:1,250 scales.

Map Name(s) and Date(s)

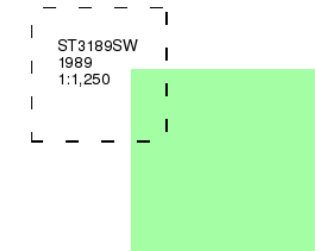

Historical Map - Segment A8

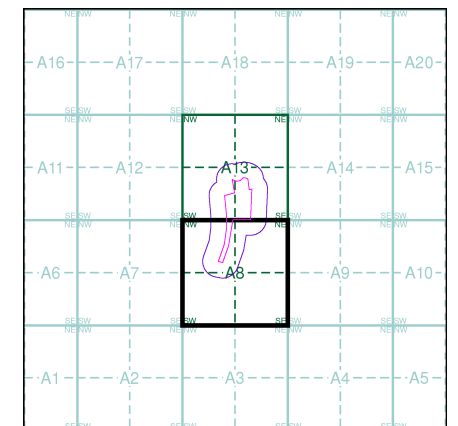

Order Details

Order Number: 41914630_1_1
Customer Ref: 12044
National Grid Reference: 331690, 189280
Slice: A
Site Area (Ha): 4.52
Search Buffer (m): 100

Site Details

., Herbert Road, NEWPORT, Gwent, NP19 7BH



Tel: 0844 844 9952
Fax: 0844 844 9951
Web: www.envirocheck.co.uk

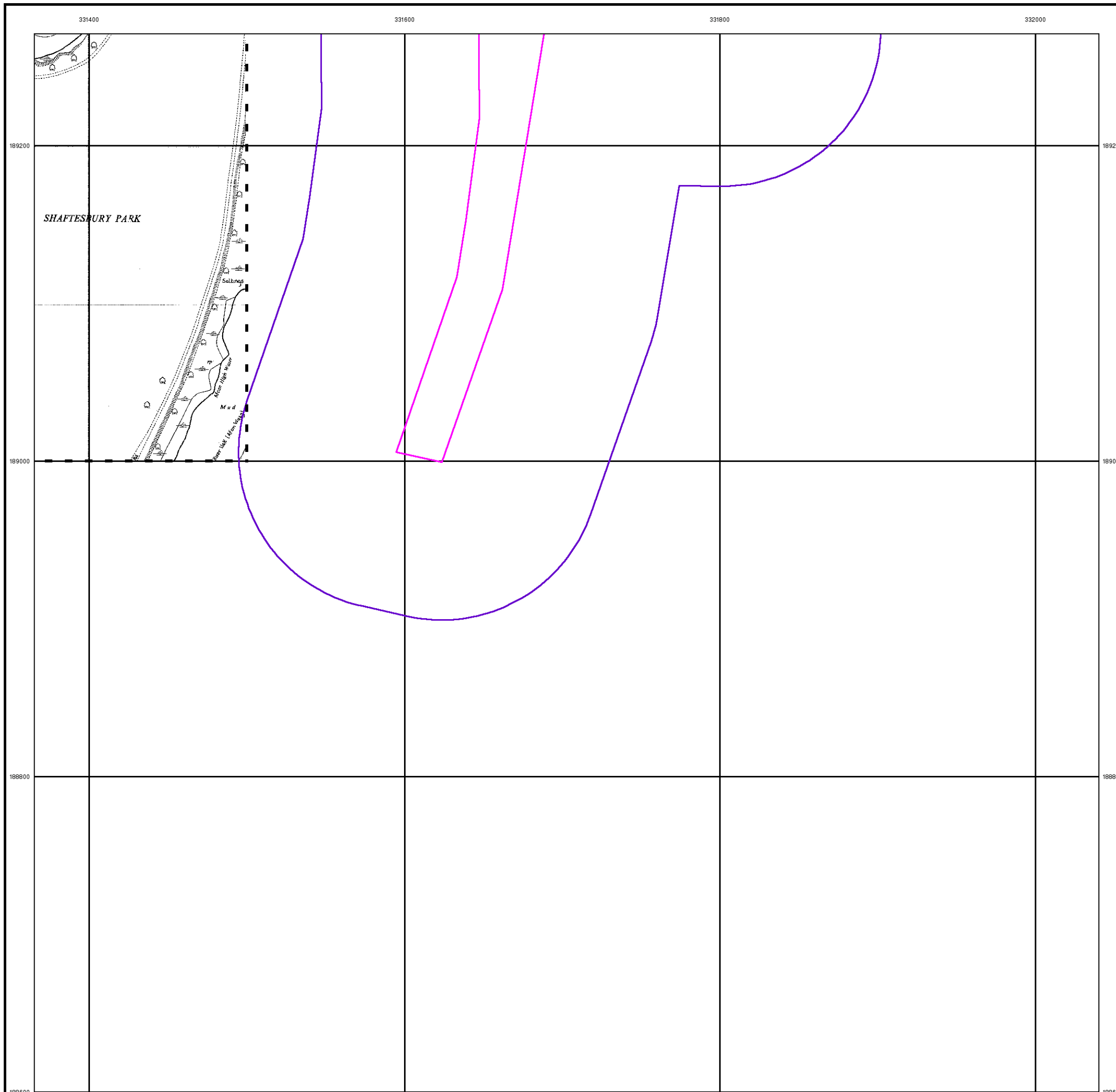



Large-Scale National Grid Data

Published 1993

Source map scale - 1:1,250

'Large Scale National Grid Data' superseded SIM cards (Ordnance Survey's 'Survey of Information on Microfilm') in 1992, and continued to be produced until 1999. These maps were the fore-runners of digital mapping and so provide detailed information on houses and roads, but tend to show less topographic features such as vegetation. These maps were produced at both 1:2,500 and 1:1,250 scales.

Map Name(s) and Date(s)

| | | |
|-----------------------------|-----------------------------|-----------------------------|
| ST3189SW 1993 1:1,250 | ST3189SE 1993 1:1,250 | ST3289SW 1993 1:1,250 |
| ST3188NW 1993 1:1,250 | ST3188NE 1993 1:1,250 | ST3288NW 1993 1:1,250 |

Historical Map - Segment A8

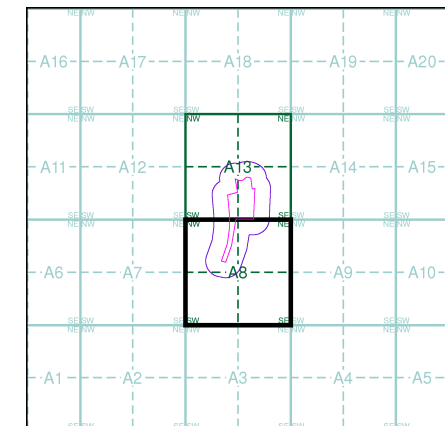

Order Details

Order Number: 41914630_1_1
 Customer Ref: 12044
 National Grid Reference: 331690, 189280
 Slice: A
 Site Area (Ha): 4.52
 Search Buffer (m): 100

Site Details

Herbert Road, NEWPORT, Gwent, NP19 7BH



Tel: 0844 844 9952
 Fax: 0844 844 9951
 Web: www.envirocheck.co.uk

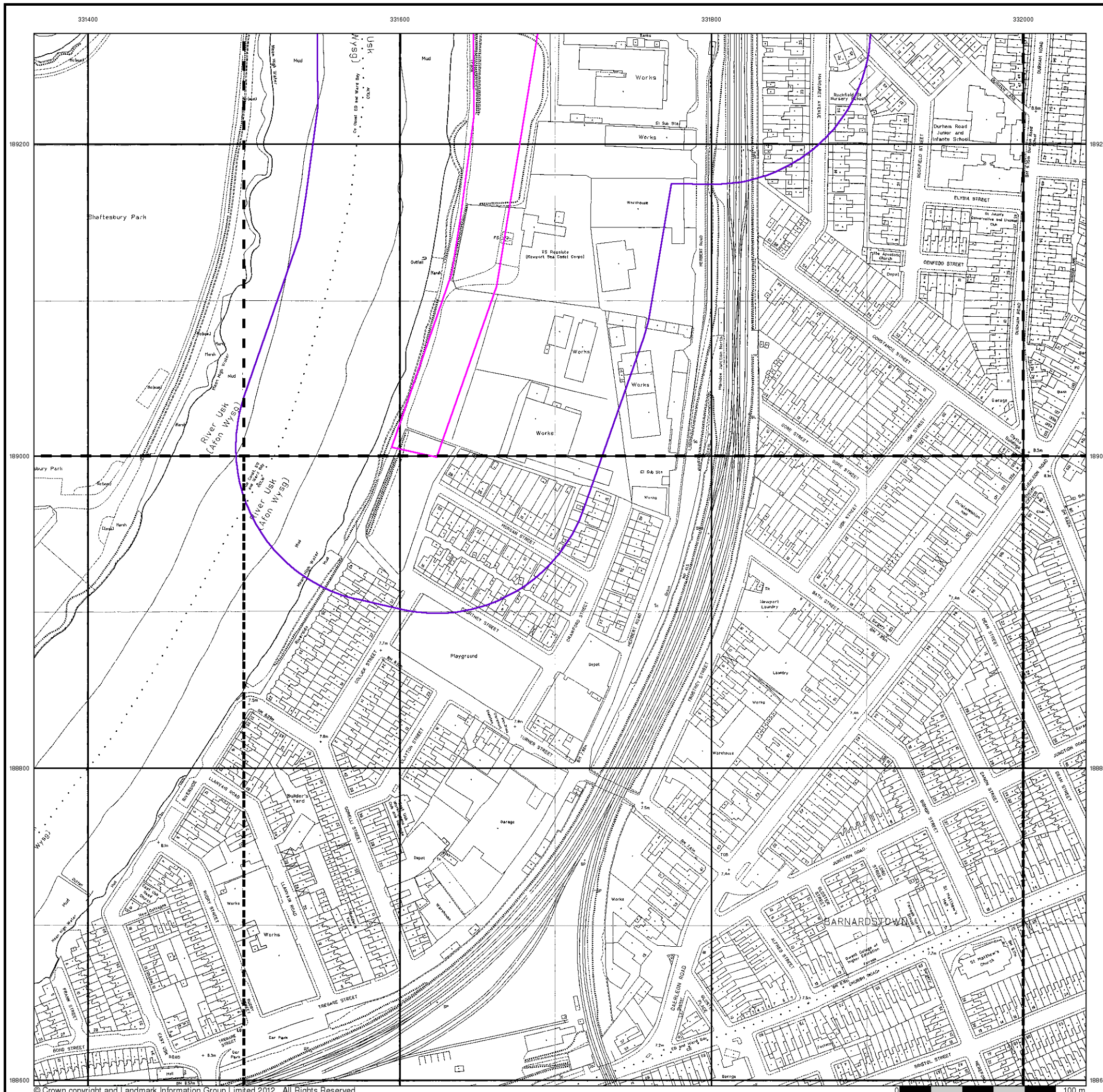



Large-Scale National Grid Data

Published 1994 - 1997

Source map scale - 1:1,250

'Large Scale National Grid Data' superseded SIM cards (Ordnance Survey's 'Survey of Information on Microfilm') in 1992, and continued to be produced until 1999. These maps were the fore-runners of digital mapping and so provide detailed information on houses and roads, but tend to show less topographic features such as vegetation. These maps were produced at both 1:2,500 and 1:1,250 scales.

Map Name(s) and Date(s)

| | | |
|-----------------------------|-----------------------------|-----------------------------|
| ST3189SW 1994 1:1,250 | ST3189SE 1994 1:1,250 | |
| ST3188NW 1995 1:1,250 | ST3188NE 1994 1:1,250 | ST3288NW 1997 1:1,250 |

Historical Map - Segment A8

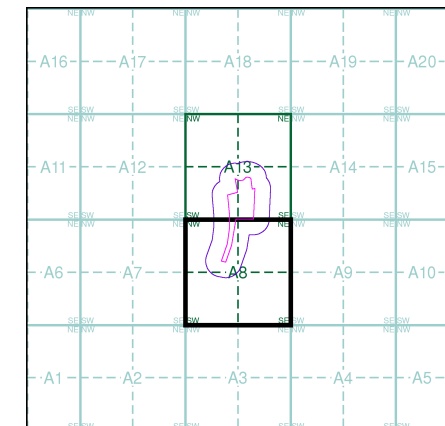

Order Details

Order Number: 41914630_1_1
 Customer Ref: 12044
 National Grid Reference: 331690, 189280
 Slice: A
 Site Area (Ha): 4.52
 Search Buffer (m): 100

Site Details

., Herbert Road, NEWPORT, Gwent, NP19 7BH



Tel: 0844 844 9952
 Fax: 0844 844 9951
 Web: www.envirocheck.co.uk

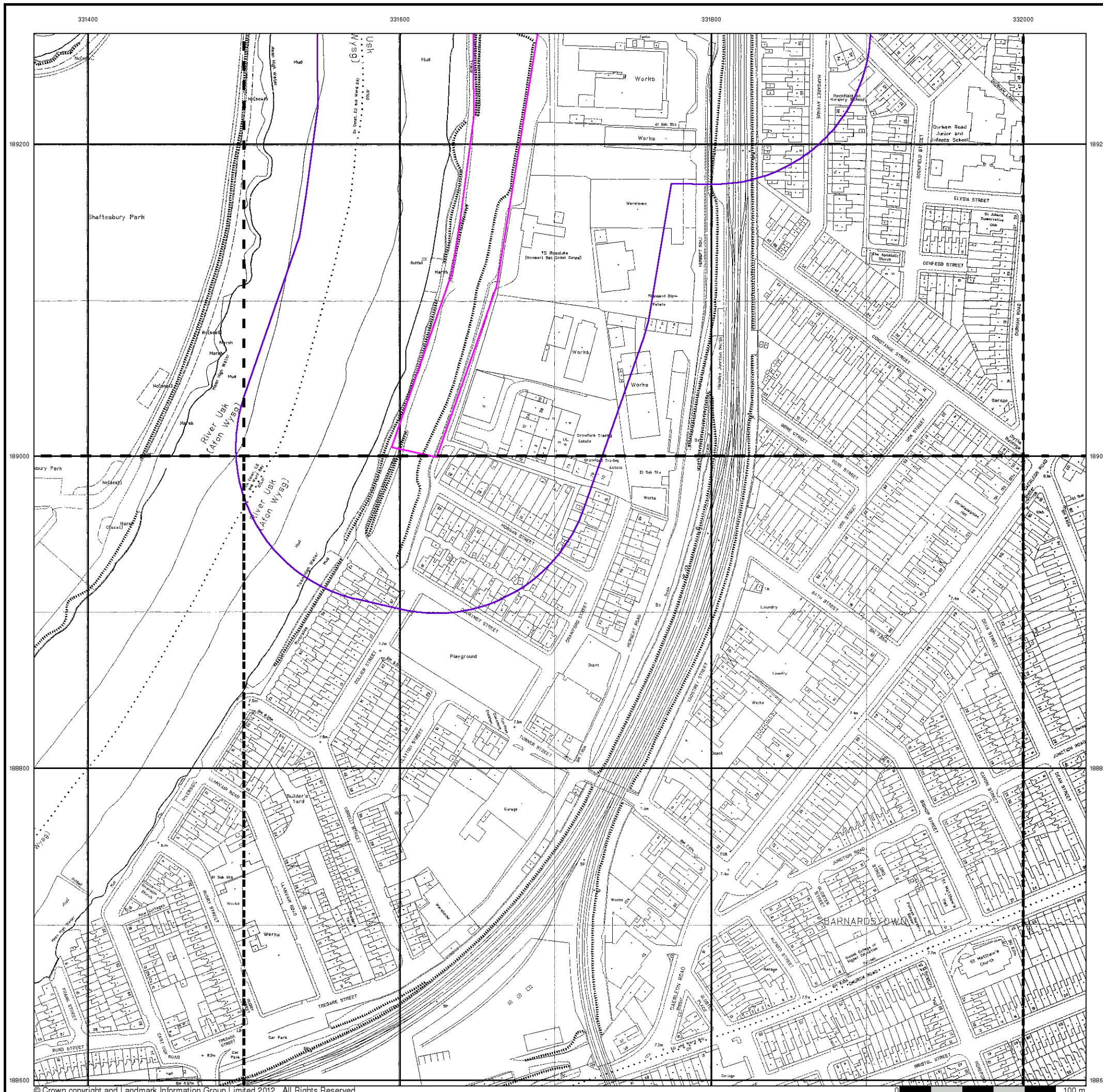



Large-Scale National Grid Data

Published 1997

Source map scale - 1:1,250

'Large Scale National Grid Data' superseded SIM cards (Ordnance Survey's 'Survey of Information on Microfilm') in 1992, and continued to be produced until 1999. These maps were the fore-runners of digital mapping and so provide detailed information on houses and roads, but tend to show less topographic features such as vegetation. These maps were produced at both 1:2,500 and 1:1,250 scales.

Map Name(s) and Date(s)

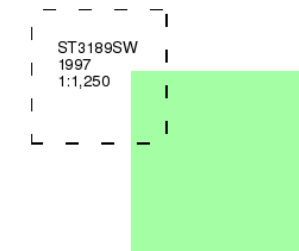

Historical Map - Segment A8

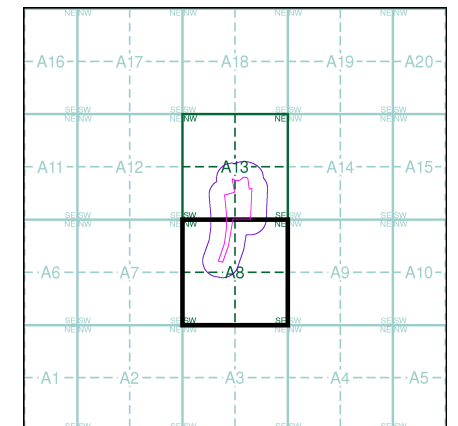

Order Details

Order Number: 41914630_1_1
Customer Ref: 12044
National Grid Reference: 331690, 189280
Slice: A
Site Area (Ha): 4.52
Search Buffer (m): 100

Site Details

., Herbert Road, NEWPORT, Gwent, NP19 7BH



Tel: 0844 844 9952
Fax: 0844 844 9951
Web: www.envirocheck.co.uk

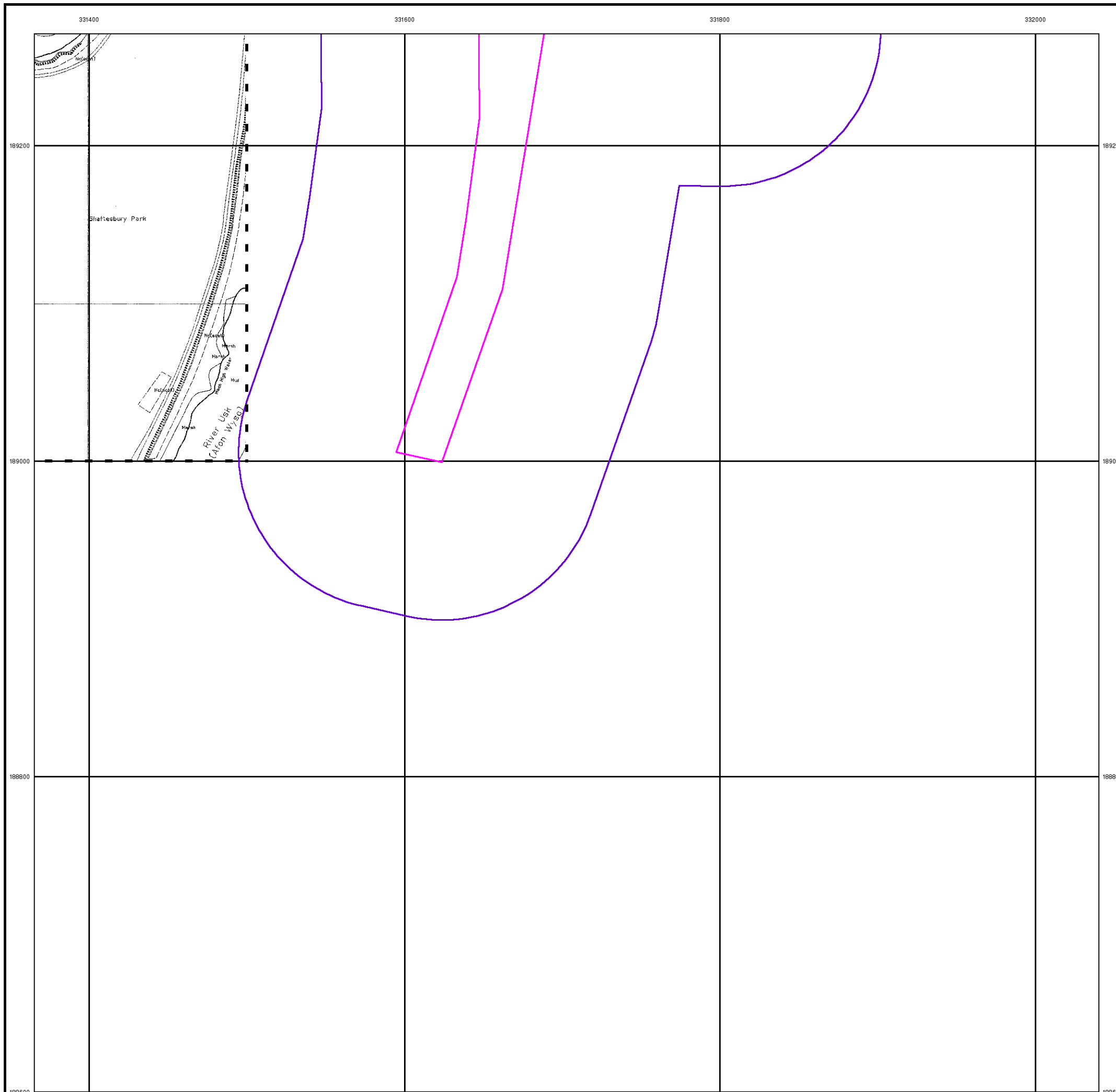

Historical Mapping Legends

Ordnance Survey County Series 1:10,560

| | | | | | |
|--|---|--|-----------------------------|--|---------------|
| | Gravel Pit | | Sand Pit | | Other Pits |
| | Quarry | | Shingle | | Orchard |
| | Osiers | | Reeds | | Marsh |
| | Mixed Wood | | Deciduous | | Brushwood |
| | Fir | | Furze | | Rough Pasture |
| | Arrow denotes flow of water | | Trigonometrical Station | | |
| | Site of Antiquities | | Bench Mark | | |
| | Pump, Guide Post, Signal Post | | Well, Spring, Boundary Post | | |
| | -285 Surface Level | | | | |
| | Sketched Contour | | Instrumental Contour | | |
| | Main Roads | | Minor Roads | | |
| | Sunken Road | | Raised Road | | |
| | Road over Railway | | Railway over River | | |
| | Railway over Road | | Level Crossing | | |
| | Road over River or Canal | | Road over Stream | | |
| | Road over Stream | | | | |
| | County Boundary (Geographical) | | | | |
| | County & Civil Parish Boundary | | | | |
| | Administrative County & Civil Parish Boundary | | | | |
| | County Borough Boundary (England) | | | | |
| | County Burgh Boundary (Scotland) | | | | |
| | Rural District Boundary | | | | |
| | Civil Parish Boundary | | | | |

Ordnance Survey Plan 1:10,000

| | | | |
|--|---|--|-------------------------|
| | Chalk Pit, Clay Pit or Quarry | | Gravel Pit |
| | Sand Pit | | Disused Pit or Quarry |
| | Refuse or Slag Heap | | Lake, Loch or Pond |
| | Dunes | | Boulders |
| | Coniferous Trees | | Non-Coniferous Trees |
| | Orchard | | Scrub |
| | Coppice | | |
| | Bracken | | Heath |
| | Rough Grassland | | |
| | Marsh | | Reeds |
| | Saltings | | |
| | Building | | Glasshouse |
| | Sloping Masonry | | Pylon |
| | Electricity Transmission Line | | Pole |
| | Cutting | | Embankment |
| | Standard Gauge Multiple Track | | |
| | Standard Gauge Single Track | | |
| | Siding, Tramway or Mineral Line | | |
| | Narrow Gauge | | |
| | Geographical County | | |
| | Administrative County, County Borough or County of City | | |
| | Municipal Borough, Urban or Rural District, Burgh or District Council | | |
| | Borough, Burgh or County Constituency Shown only when not coincident with other boundaries | | |
| | Civil Parish Shown alternately when coincidence of boundaries occurs | | |
| | BP, BS Boundary Post or Stone | | Pol Sta Police Station |
| | Ch Church | | PO Post Office |
| | CH Club House | | PC Public Convenience |
| | F E Sta Fire Engine Station | | PH Public House |
| | FB Foot Bridge | | SB Signal Box |
| | Fn Fountain | | Spr Spring |
| | GP Guide Post | | TCB Telephone Call Box |
| | MP Mile Post | | TCP Telephone Call Post |
| | MS Mile Stone | | W Well |

1:10,000 Raster Mapping

| | | | |
|--|--|--|--|
| | Gravel Pit | | Refuse tip or slag heap |
| | Rock | | Rock (scattered) |
| | Boulders | | Boulders (scattered) |
| | Shingle | | Mud |
| | Sand | | Sand Pit |
| | Slopes | | Top of cliff |
| | General detail | | Underground detail |
| | Overhead detail | | Narrow gauge railway |
| | Multi-track railway | | Single track railway |
| | County boundary (England only) | | Civil, parish or community boundary |
| | District, Unitary, Metropolitan, London Borough boundary | | Constituency boundary |
| | Area of wooded vegetation | | Non-coniferous trees |
| | Non-coniferous trees (scattered) | | Coniferous trees |
| | Coniferous trees (scattered) | | Positioned tree |
| | Orchard | | Coppice or Osiers |
| | Rough Grassland | | Heath |
| | Scrub | | Marsh, Salt Marsh or Reeds |
| | Water feature | | Flow arrows |
| | MHW(S) Mean high water (springs) | | MLW(S) Mean low water (springs) |
| | Telephone line (where shown) | | Electricity transmission line (with poles) |
| | Bench mark (where shown) | | Triangulation station |
| | Point feature (e.g. Guide Post or Mile Stone) | | Pylon, flare stack or lighting tower |
| | Site of (antiquity) | | Glasshouse |
| | General Building | | Important Building |



Historical Mapping & Photography included:

| Mapping Type | Scale | Date | Pg |
|-------------------------------|----------|-------------|----|
| Monmouthshire | 1:10,560 | 1886 | 3 |
| Monmouthshire | 1:10,560 | 1902 | 4 |
| Monmouthshire | 1:10,560 | 1922 | 5 |
| Monmouthshire | 1:10,560 | 1938 | 6 |
| Historical Aerial Photography | 1:10,560 | 1947 | 7 |
| Historical Aerial Photography | 1:10,560 | 1947 | 8 |
| Monmouthshire | 1:10,560 | 1954 | 9 |
| Ordnance Survey Plan | 1:10,000 | 1964 - 1965 | 10 |
| Ordnance Survey Plan | 1:10,000 | 1972 - 1973 | 11 |
| Ordnance Survey Plan | 1:10,000 | 1981 - 1983 | 12 |
| Newport | 1:10,000 | 1983 | 13 |
| Ordnance Survey Plan | 1:10,000 | 1987 | 14 |
| 10K Raster Mapping | 1:10,000 | 2006 | 15 |
| 10K Raster Mapping | 1:10,000 | 2012 | 16 |

Historical Map - Slice A

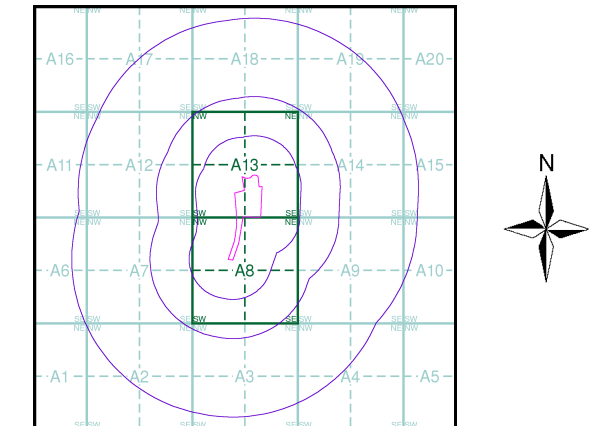

Order Details

Order Number: 41914630_1_1
 Customer Ref: 12044
 National Grid Reference: 331690, 189280
 Slice: A
 Site Area (Ha): 4.52
 Search Buffer (m): 1000

Site Details

., Herbert Road, NEWPORT, Gwent, NP19 7BH



Tel: 0844 844 9952
 Fax: 0844 844 9951
 Web: www.envirocheck.co.uk

Russian Military Mapping Legends

1:5,000 and 1:10,000 mapping

a. Not drawn to scale b. Drawn to scale

| | | | |
|--|--|--|---|
| | Government and Administrative Buildings | | Military and Industrial Buildings |
| | Military and Communication Areas | | Subway Entrance |
| | Fireproof Building | | Prominent Fireproof Building |
| | Non-fireproof Building | | Non-fireproof Building (non-dwelling) |
| | Factory, mill, and flour mill, with chimneys | | Factory, mill, and flour mill, without chimneys |
| | Power Station, drawn to scale | | Hydroelectric Power Station |
| | Radio Station, drawn to scale | | Telephone Station, drawn to scale |
| | Abandoned Open-pit Mine or Quarry | | Open-pit Salt Mine |
| | Pit | | Oil Deposit or Well |
| | Oil Seepage | | Natural Gas Tank |
| | Tailings Pile | | Fuel Storage Tanks |
| | Bench Mark | | Drill Hole |
| | Burial Mound | | Triangulation Point on Burial Mound |
| | Single-track Railroad | | Double-track Railroad |
| | Railroad and Station Building | | Small Bridge |
| | Tunnel | | Pipe (Culvert) |
| | Coniferous Forest | | Deciduous Forest |
| | Mixed Forest | | Lawns |
| | Citrus Orchard | | Wet Ground |
| | Scattered Vegetation | | |

243,8 Values for prominent elevations
186.0 Numbers for spot elevations, depth soundings, contour lines, etc.
0,2 Velocity of the current, width of river bed, depth of river
180/12 Fractional terms: length and capacity of bridges; depth of fords and condition of the river bottom; height of forest and the diameter of trees

Russian Alphabet (For reference and phonetic interpretation of map text)

| | | | |
|-----------------|----------------|-----------------|-----------------------|
| А а (A) | З з (Z) | П п (P) | Ч ч (CH) |
| Б б (B) | И и (I) | Р р (R) | Ш ш (SH) |
| В в (V) | Й й (Y) | С с (S) | Щ щ (SHCH) |
| Г г (G) | К к (K) | Т т (T) | Ъ (-) |
| Д д (D) | Л л (L) | У у (U) | Ы (Y) |
| Е е (E) | М м (M) | Ф ф (F) | Ь (') |
| Ё ё (YO) | Н н (N) | Х х (KH) | Э э (E) |
| Ж ж (ZH) | О о (O) | Ц ц (TS) | Ю ю (YU or IU) |
| | | | Я я (YA or IA) |

1:25,000 mapping

a. Not drawn to scale b. Drawn to scale

| | | | |
|--|--|--|--|
| | Government and Administrative Buildings | | Military and Industrial Buildings |
| | Military and Communication Areas | | Subway Entrance |
| | Partly Demolished Buildings | | Demolished Buildings |
| | Built-Up Area with Fireproof Buildings Predominant | | Built-Up Area with Non-Fireproof Buildings Predominant |
| | Individual Fireproof Building | | Prominent Industrial Building |
| | Individual Dwelling, Fireproof | | Ruins of an Individual Dwelling |
| | Factory or Mill Chimney | | Factory or Mill with Chimney |
| | Factory or Mill without Chimney | | Salt Mine |
| | Tailings Pile | | Pit |
| | Stone Quarry | | Gas Pump or Service Station |
| | Fuel Storage or Natural Gas Tank | | Oil or Natural Gas Derrick |
| | Small Hydroelectric Power Station | | Power Station |
| | Transformer Station | | Cemetery |
| | Burial Mound (height in metres) | | Triangulation Point on Burial Mound |
| | Triangulation Point | | Bench Mark |
| | Bench Mark (monumented) | | Telegraph Office |
| | Telephone Station | | Radio Station |
| | Radio Tower | | Airfield or Seaplane Base |
| | Landing Strip | | Cut |
| | Fill | | Km Post |
| | Plantings | | Width of Road |
| | Steep Grade | | Telegraph/Telephone Lines |
| | Main Highway | | Highway under Construction |
| | Improved Dirt Road (former truck road) | | Small Bridge |
| | Pipe (Culvert) | | Tunnel |
| | Dismantled Railroad | | Double-track Railroad with First Class Station |
| | Railroad Under Construction | | Shore Embankment |
| | River or Ditch with Embankment | | Water Gauge |
| | Direction and velocity of current | | Water Level Mark |
| | Well | | Spring |
| | Water Reservoir or Rain Water Pit | | Isobath with value |
| | Contour Line and Value | | Half Contour Line |
| | Spot Elevation Value | | Coniferous |
| | Deciduous | | Mixed |
| | Scrub | | |

Key to Numbers on Mapping

ST38NW_Newport

| No. | Description |
|-----|---|
| 15 | Factory (Gas) |
| 16 | Factory (Gas) |
| 21 | Factory (Machinery) |
| 23 | Factory (Metals) |
| 35 | Factory (Non-Ferrous Metals) |
| 40 | Council/Government Buildings/Courts |
| 44 | Police Station/Headquarters |
| 58 | Post Office |
| 59 | Warehouses (Use Unknown) |
| 63 | Warehouses (Use Unknown) And Port Buildings |
| 73 | Railway Station |



Historical Mapping & Photography included:

| Mapping Type | Scale | Date | Pg |
|-------------------------------|----------|-------------|----|
| Monmouthshire | 1:10,560 | 1886 | 3 |
| Monmouthshire | 1:10,560 | 1902 | 4 |
| Monmouthshire | 1:10,560 | 1922 | 5 |
| Monmouthshire | 1:10,560 | 1938 | 6 |
| Historical Aerial Photography | 1:10,560 | 1947 | 7 |
| Historical Aerial Photography | 1:10,560 | 1947 | 8 |
| Monmouthshire | 1:10,560 | 1954 | 9 |
| Ordnance Survey Plan | 1:10,000 | 1964 - 1965 | 10 |
| Ordnance Survey Plan | 1:10,000 | 1972 - 1973 | 11 |
| Ordnance Survey Plan | 1:10,000 | 1981 - 1983 | 12 |
| Newport | 1:10,000 | 1983 | 13 |
| Ordnance Survey Plan | 1:10,000 | 1987 | 14 |
| 10K Raster Mapping | 1:10,000 | 2006 | 15 |
| 10K Raster Mapping | 1:10,000 | 2012 | 16 |

Russian Map - Slice A

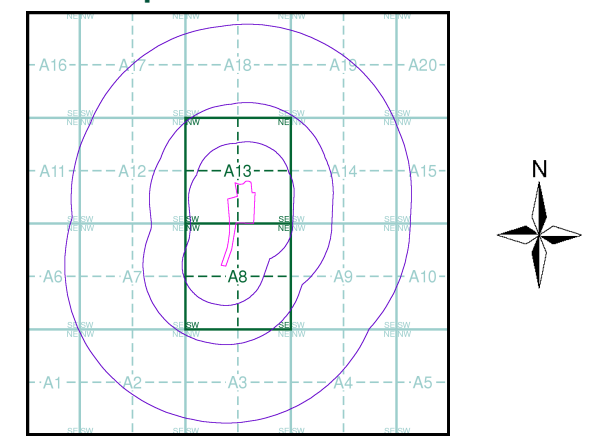

Order Details

Order Number: 41914630_1_1
 Customer Ref: 12044
 National Grid Reference: 331690, 189280
 Slice: A
 Site Area (Ha): 4.52
 Search Buffer (m): 1000

Site Details

., Herbert Road, NEWPORT, Gwent, NP19 7BH

| | |
|--|--|
| | Tel: 0844 844 9952 Fax: 0844 844 9951 Web: www.envirocheck.co.uk |
|--|--|



Monmouthshire

Published 1886

Source map scale - 1:10,560

The historical maps shown were reproduced from maps predominantly held at the scale adopted for England, Wales and Scotland in the 1840's. In 1854 the 1:2,500 scale was adopted for mapping urban areas; these maps were used to update the 1:10,560 maps. The published date given therefore is often some years later than the surveyed date. Before 1938, all OS maps were based on the Cassini Projection, with independent surveys of a single county or group of counties, giving rise to significant inaccuracies in outlying areas. In the late 1940's, a Provisional Edition was produced, which updated the 1:10,560 mapping from a number of sources. The maps appear unfinished - with all military camps and other strategic sites removed. These maps were initially overprinted with the National Grid. In 1970, the first 1:10,000 maps were produced using the Transverse Mercator Projection. The revision process continued until recently, with new editions appearing every 10 years or so for urban areas.

Map Name(s) and Date(s)

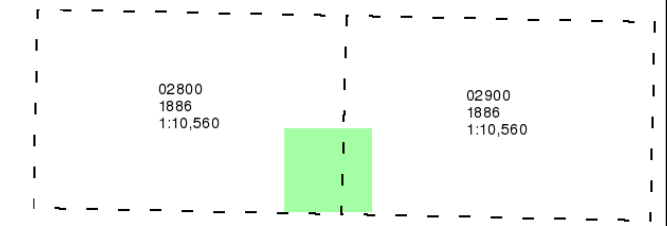

Historical Map - Slice A

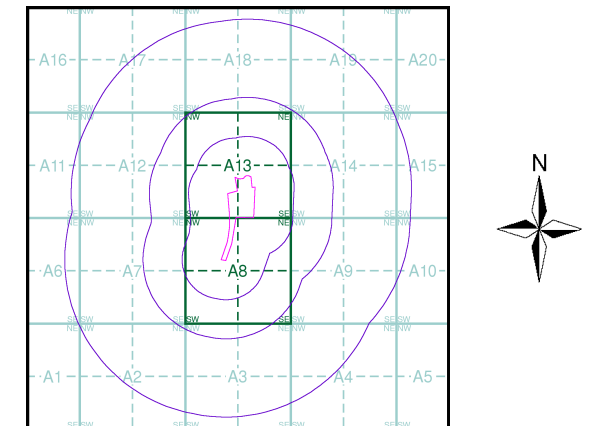

Order Details

Order Number: 41914630_1_1
Customer Ref: 12044
National Grid Reference: 331690, 189280
Slice: A
Site Area (Ha): 4.52
Search Buffer (m): 1000

Site Details

Herbert Road, NEWPORT, Gwent, NP19 7BH



Tel: 0844 844 9952
Fax: 0844 844 9951
Web: www.envirocheck.co.uk

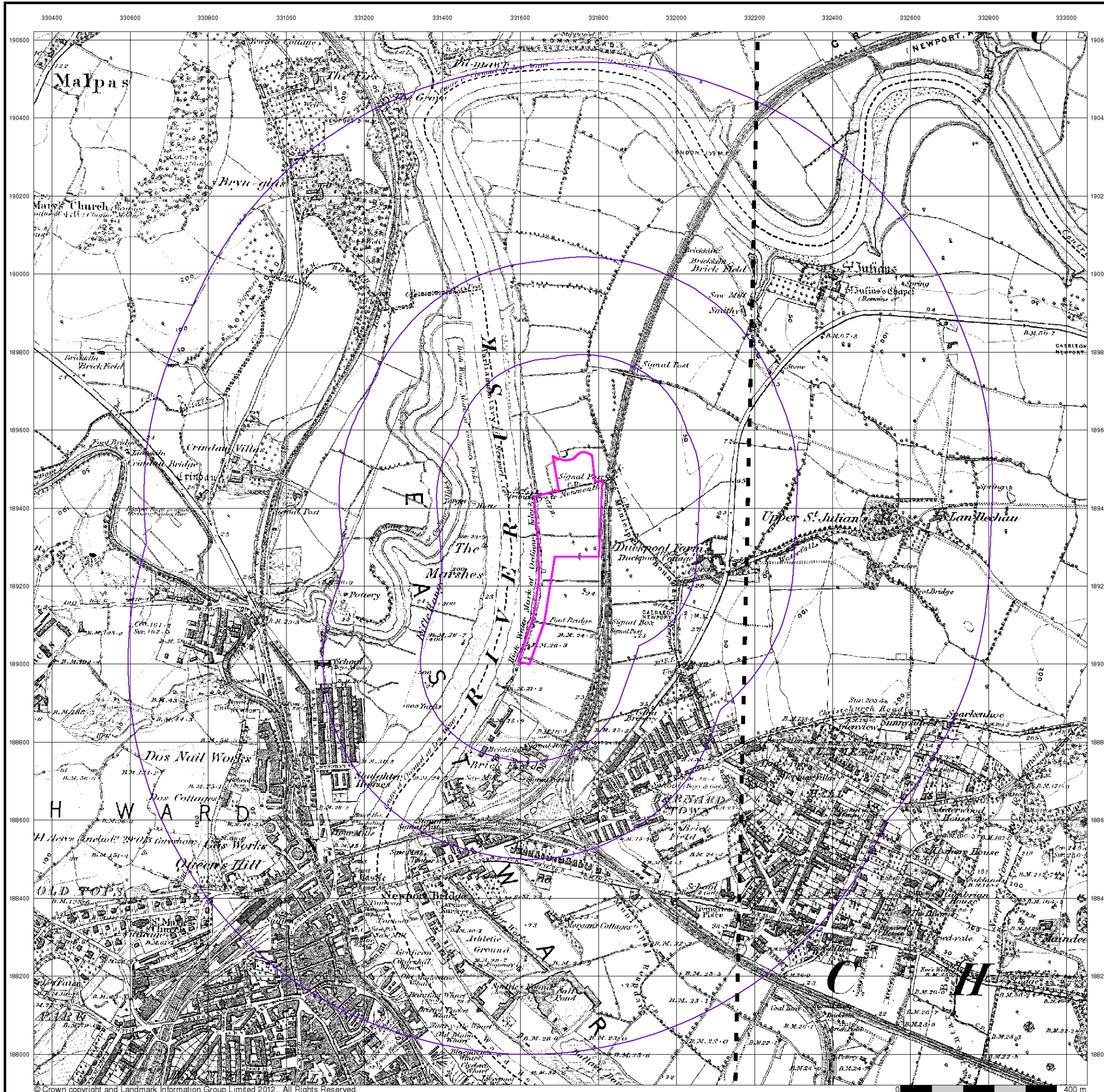

The historical maps shown were reproduced from maps predominantly held at the scale adopted for England, Wales and Scotland in the 1840's. In 1854 the 1:2,500 scale was adopted for mapping urban areas; these maps were used to update the 1:10,560 maps. The published date given therefore is often some years later than the surveyed date. Before 1938, all OS maps were based on the Cassini Projection, with independent surveys of a single county or group of counties, giving rise to significant inaccuracies in outlying areas. In the late 1940's, a Provisional Edition was produced, which updated the 1:10,560 mapping from a number of sources. The maps appear unfinished - with all military camps and other strategic sites removed. These maps were initially overprinted with the National Grid. In 1970, the first 1:10,000 maps were produced using the Transverse Mercator Projection. The revision process continued until recently, with new editions appearing every 10 years or so for urban areas.

Map Name(s) and Date(s)

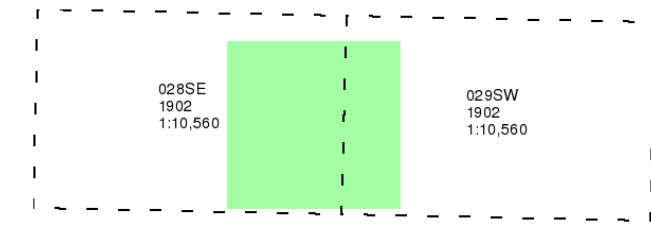

Historical Map - Slice A

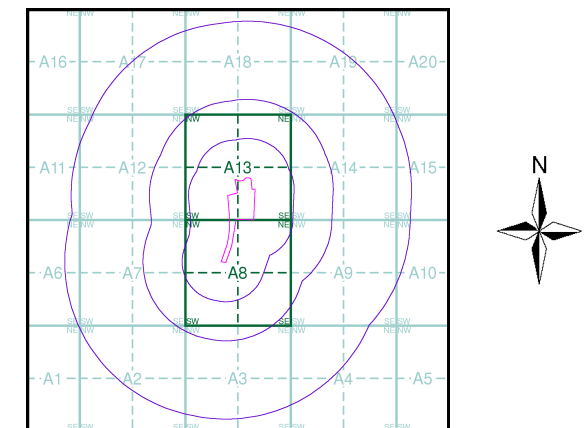

Order Details

Order Number: 41914630_1_1
 Customer Ref: 12044
 National Grid Reference: 331690, 189280
 Slice: A
 Site Area (Ha): 4.52
 Search Buffer (m): 1000

Site Details

Herbert Road, NEWPORT, Gwent, NP19 7BH

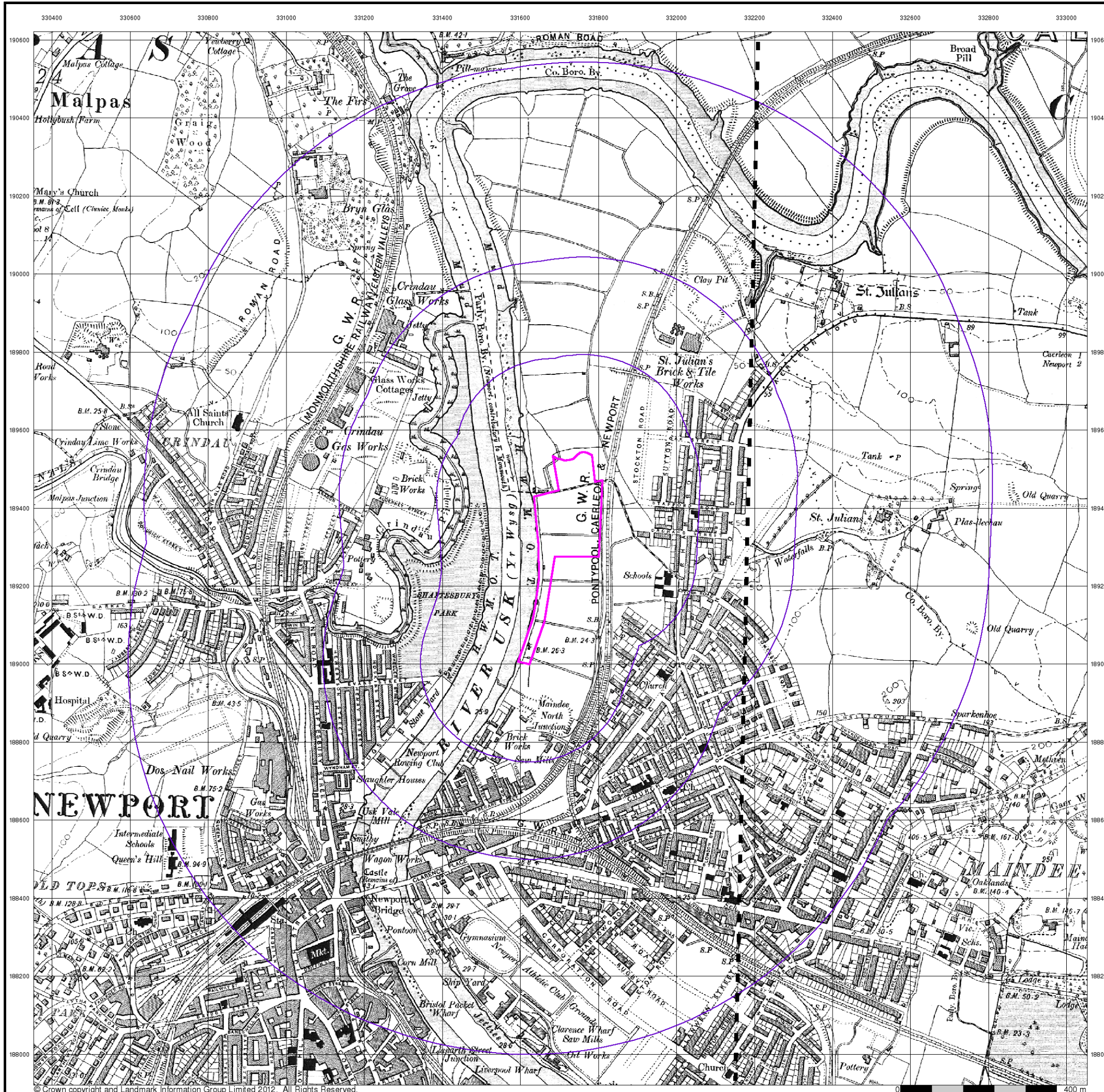



Monmouthshire

Published 1922

Source map scale - 1:10,560

The historical maps shown were reproduced from maps predominantly held at the scale adopted for England, Wales and Scotland in the 1840's. In 1854 the 1:2,500 scale was adopted for mapping urban areas; these maps were used to update the 1:10,560 maps. The published date given therefore is often some years later than the surveyed date. Before 1938, all OS maps were based on the Cassini Projection, with independent surveys of a single county or group of counties, giving rise to significant inaccuracies in outlying areas. In the late 1940's, a Provisional Edition was produced, which updated the 1:10,560 mapping from a number of sources. The maps appear unfinished - with all military camps and other strategic sites removed. These maps were initially overprinted with the National Grid. In 1970, the first 1:10,000 maps were produced using the Transverse Mercator Projection. The revision process continued until recently, with new editions appearing every 10 years or so for urban areas.

Map Name(s) and Date(s)

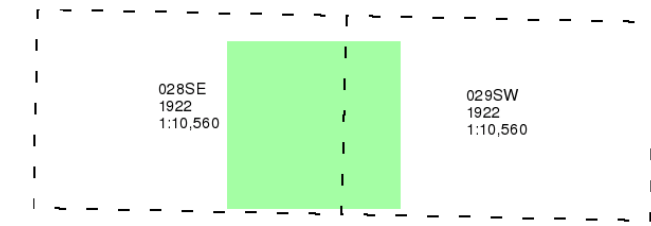

Historical Map - Slice A

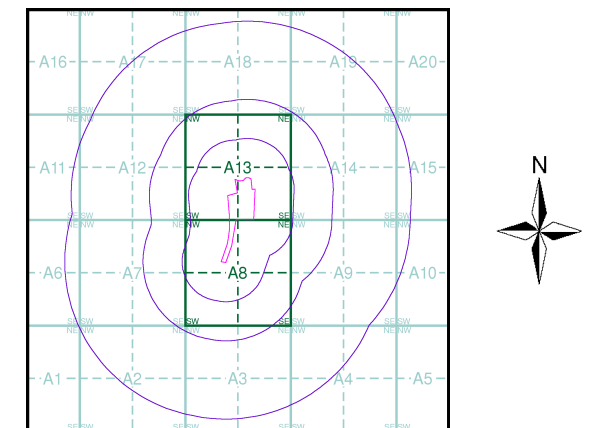

Order Details

Order Number: 41914630_1_1
Customer Ref: 12044
National Grid Reference: 331690, 189280
Slice: A
Site Area (Ha): 4.52
Search Buffer (m): 1000

Site Details

Herbert Road, NEWPORT, Gwent, NP19 7BH



Tel: 0844 844 9952
Fax: 0844 844 9951
Web: www.envirocheck.co.uk



The historical maps shown were reproduced from maps predominantly held at the scale adopted for England, Wales and Scotland in the 1840's. In 1854 the 1:2,500 scale was adopted for mapping urban areas; these maps were used to update the 1:10,560 maps. The published date given therefore is often some years later than the surveyed date. Before 1938, all OS maps were based on the Cassini Projection, with independent surveys of a single county or group of counties, giving rise to significant inaccuracies in outlying areas. In the late 1940's, a Provisional Edition was produced, which updated the 1:10,560 mapping from a number of sources. The maps appear unfinished - with all military camps and other strategic sites removed. These maps were initially overprinted with the National Grid. In 1970, the first 1:10,000 maps were produced using the Transverse Mercator Projection. The revision process continued until recently, with new editions appearing every 10 years or so for urban areas.

Map Name(s) and Date(s)

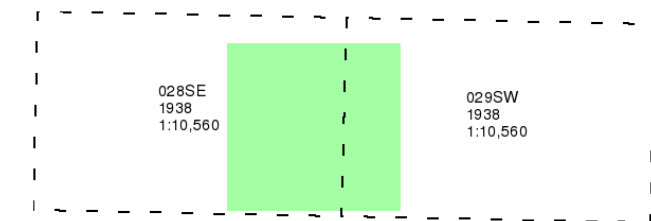

Historical Map - Slice A

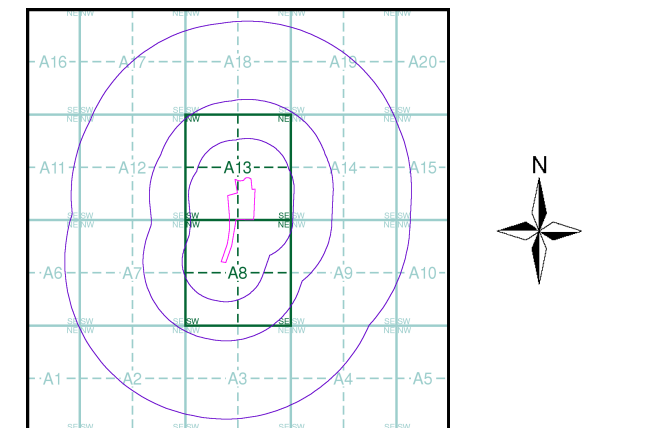

Order Details

Order Number: 41914630_1_1
 Customer Ref: 12044
 National Grid Reference: 331690, 189280
 Slice: A
 Site Area (Ha): 4.52
 Search Buffer (m): 1000

Site Details

Herbert Road, NEWPORT, Gwent, NP19 7BH





Historical Aerial Photography

Published 1947

Source map scale - 1:10,560

The Historical Aerial Photos were produced by the Ordnance Survey at a scale of 1:1,250 and 1:10,560 from Air Force photography. They were produced between 1944 and 1951 as an interim measure, pending preparation of conventional mapping, due to post war resource shortages. New security measures in the 1950's meant that every photograph was re-checked for potentially unsafe information with security sites replaced by fake fields or clouds. The original editions were withdrawn and only later made available after a period of fifty years although due to the accuracy of the editing, without viewing both revisions it is not easy to spot the edits. Where available Landmark have included both revisions.

© Landmark Information Group and/or Data Suppliers 2010.

Map Name(s) and Date(s)

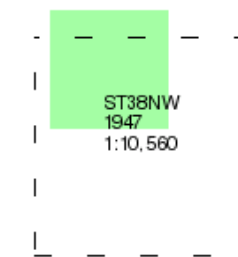

Historical Aerial Photography - Slice A

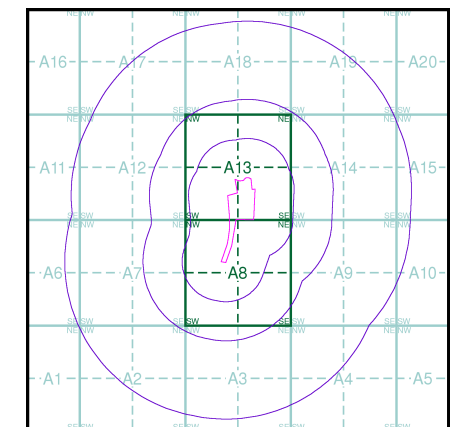

Order Details

Order Number: 41914630_1_1
Customer Ref: 12044
National Grid Reference: 331690, 189280
Slice: A
Site Area (Ha): 4.52
Search Buffer (m): 1000

Site Details

., Herbert Road, NEWPORT, Gwent, NP19 7BH



Tel: 0844 844 9952
Fax: 0844 844 9951
Web: www.envirocheck.co.uk

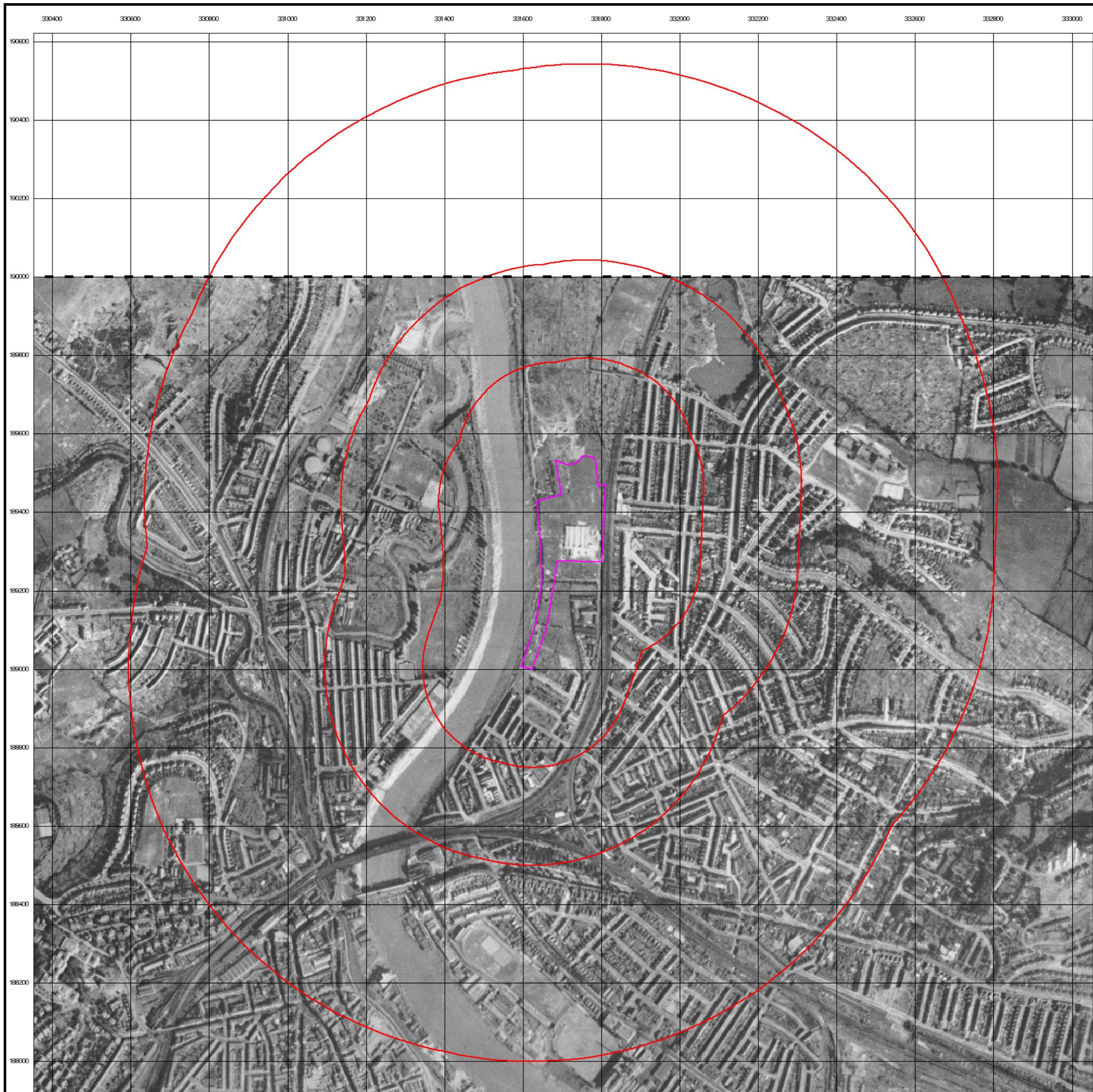



Historical Aerial Photography

Published 1947

Source map scale - 1:10,560

The Historical Aerial Photos were produced by the Ordnance Survey at a scale of 1:1,250 and 1:10,560 from Air Force photography. They were produced between 1944 and 1951 as an interim measure, pending preparation of conventional mapping, due to post war resource shortages. New security measures in the 1950's meant that every photograph was re-checked for potentially unsafe information with security sites replaced by fake fields or clouds. The original editions were withdrawn and only later made available after a period of fifty years although due to the accuracy of the editing, without viewing both revisions it is not easy to spot the edits. Where available Landmark have included both revisions.

© Landmark Information Group and/or Data Suppliers 2010.

Map Name(s) and Date(s)

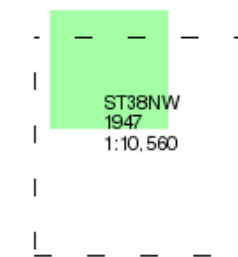

Historical Aerial Photography - Slice A

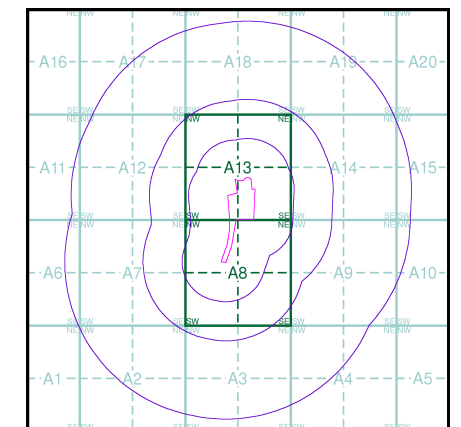

Order Details

| | |
|--------------------------|----------------|
| Order Number: | 41914630_1_1 |
| Customer Ref: | 12044 |
| National Grid Reference: | 331690, 189280 |
| Slice: | A |
| Site Area (Ha): | 4.52 |
| Search Buffer (m): | 1000 |

Site Details

., Herbert Road, NEWPORT, Gwent, NP19 7BH



| | |
|------|-----------------------|
| Tel: | 0844 844 9952 |
| Fax: | 0844 844 9951 |
| Web: | www.envirocheck.co.uk |

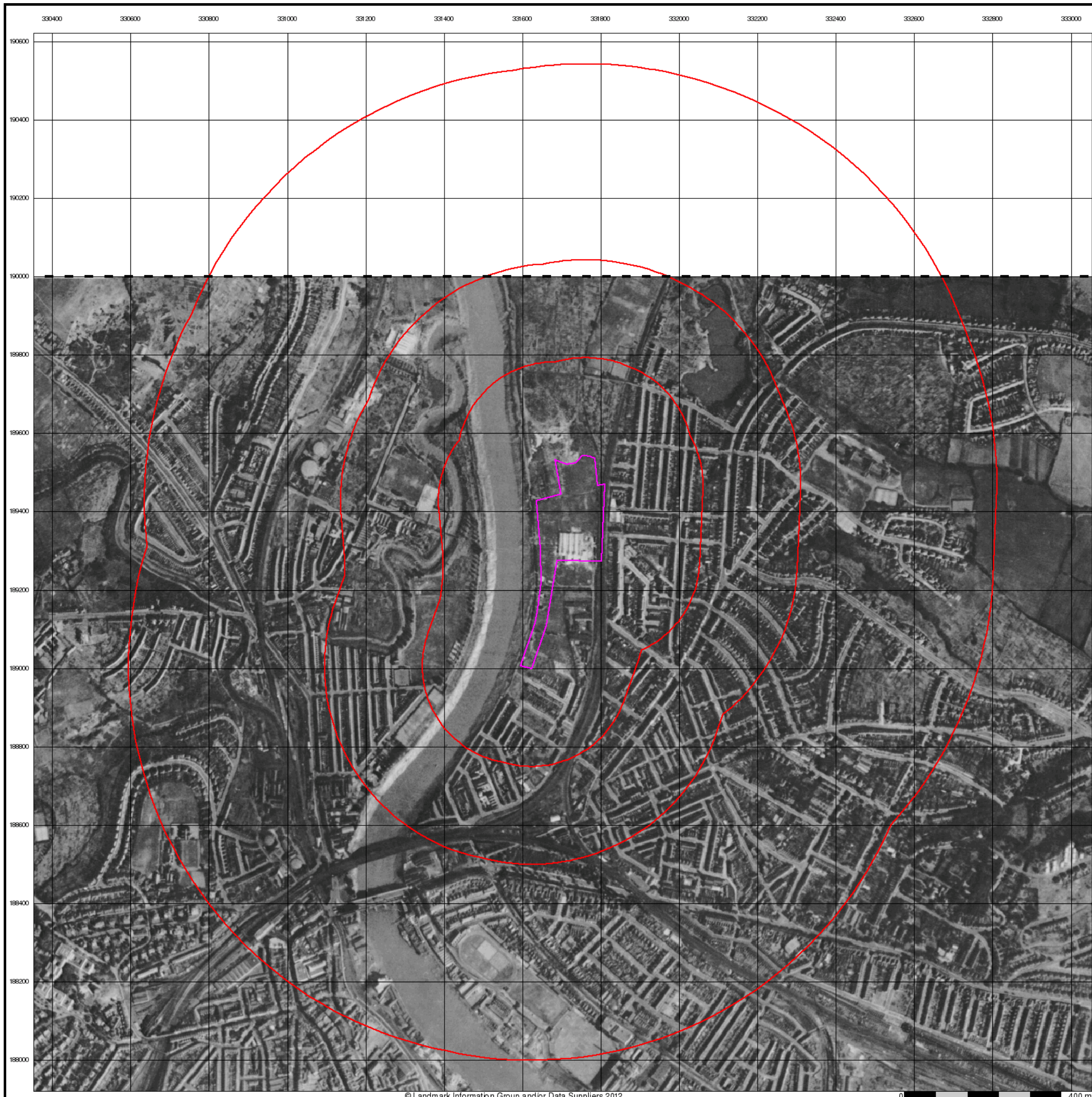

The historical maps shown were reproduced from maps predominantly held at the scale adopted for England, Wales and Scotland in the 1840's. In 1854 the 1:2,500 scale was adopted for mapping urban areas; these maps were used to update the 1:10,560 maps. The published date given therefore is often some years later than the surveyed date. Before 1938, all OS maps were based on the Cassini Projection, with independent surveys of a single county or group of counties, giving rise to significant inaccuracies in outlying areas. In the late 1940's, a Provisional Edition was produced, which updated the 1:10,560 mapping from a number of sources. The maps appear unfinished - with all military camps and other strategic sites removed. These maps were initially overprinted with the National Grid. In 1970, the first 1:10,000 maps were produced using the Transverse Mercator Projection. The revision process continued until recently, with new editions appearing every 10 years or so for urban areas.

Map Name(s) and Date(s)

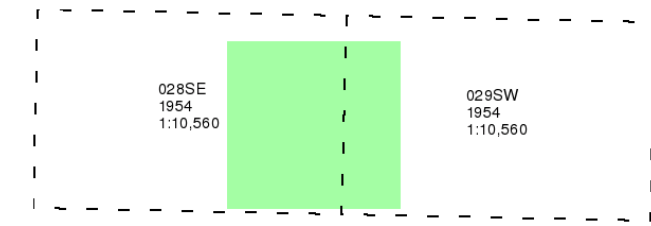

Historical Map - Slice A

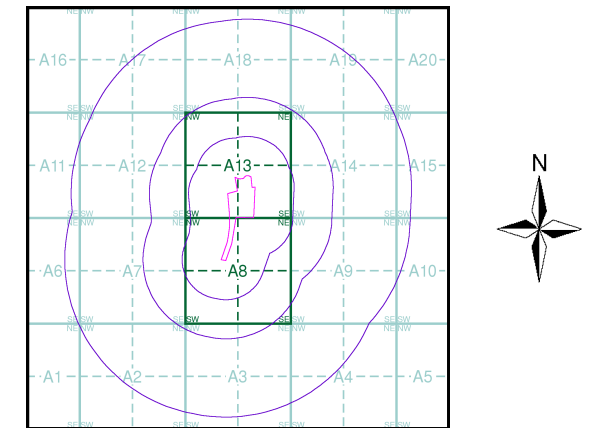

Order Details

Order Number: 41914630_1_1
 Customer Ref: 12044
 National Grid Reference: 331690, 189280
 Slice: A
 Site Area (Ha): 4.52
 Search Buffer (m): 1000

Site Details

Herbert Road, NEWPORT, Gwent, NP19 7BH



Ordnance Survey Plan

Published 1964 - 1965

Source map scale - 1:10,000

The historical maps shown were reproduced from maps predominantly held at the scale adopted for England, Wales and Scotland in the 1840's. In 1854 the 1:2,500 scale was adopted for mapping urban areas; these maps were used to update the 1:10,560 maps. The published date given therefore is often some years later than the surveyed date. Before 1938, all OS maps were based on the Cassini Projection, with independent surveys of a single county or group of counties, giving rise to significant inaccuracies in outlying areas. In the late 1940's, a Provisional Edition was produced, which updated the 1:10,560 mapping from a number of sources. The maps appear unfinished - with all military camps and other strategic sites removed. These maps were initially overprinted with the National Grid. In 1970, the first 1:10,000 maps were produced using the Transverse Mercator Projection. The revision process continued until recently, with new editions appearing every 10 years or so for urban areas.

Map Name(s) and Date(s)

| | | |
|--------|------|----------|
| ST39SW | 1964 | 1:10,560 |
| ST38NW | 1965 | 1:10,560 |

Historical Map - Slice A

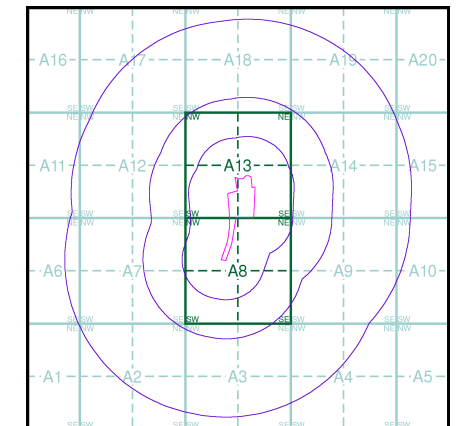

Order Details

Order Number: 41914630_1_1
 Customer Ref: 12044
 National Grid Reference: 331690, 189280
 Slice: A
 Site Area (Ha): 4.52
 Search Buffer (m): 1000

Site Details

Herbert Road, NEWPORT, Gwent, NP19 7BH

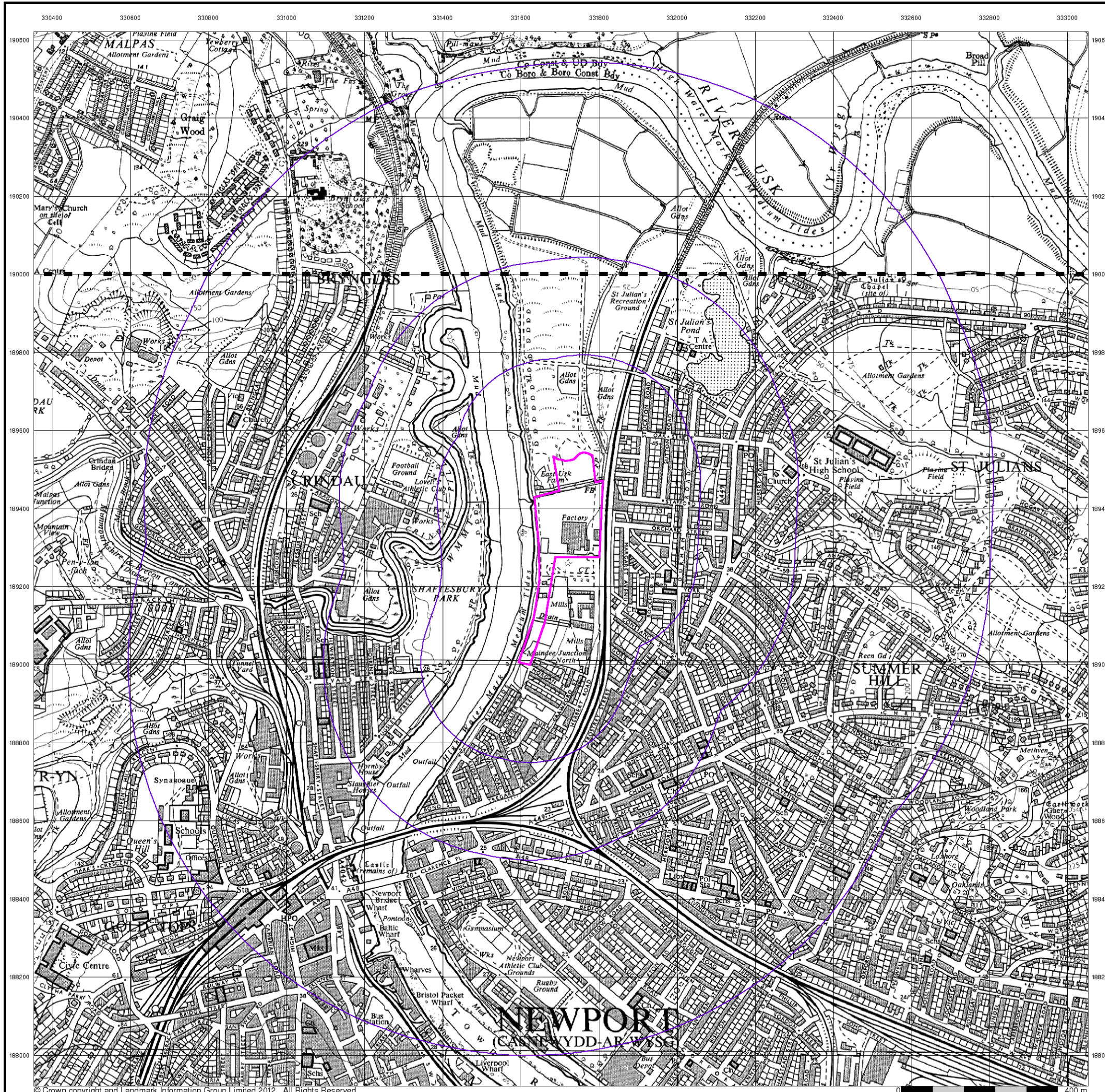

Ordnance Survey Plan

Published 1972 - 1973

Source map scale - 1:10,000

The historical maps shown were reproduced from maps predominantly held at the scale adopted for England, Wales and Scotland in the 1840's. In 1854 the 1:2,500 scale was adopted for mapping urban areas; these maps were used to update the 1:10,560 maps. The published date given therefore is often some years later than the surveyed date. Before 1938, all OS maps were based on the Cassini Projection, with independent surveys of a single county or group of counties, giving rise to significant inaccuracies in outlying areas. In the late 1940's, a Provisional Edition was produced, which updated the 1:10,560 mapping from a number of sources. The maps appear unfinished - with all military camps and other strategic sites removed. These maps were initially overprinted with the National Grid. In 1970, the first 1:10,000 maps were produced using the Transverse Mercator Projection. The revision process continued until recently, with new editions appearing every 10 years or so for urban areas.

Map Name(s) and Date(s)

| | | |
|--------|------|----------|
| ST39SW | 1972 | 1:10,000 |
| ST38NW | 1973 | 1:10,000 |

Historical Map - Slice A

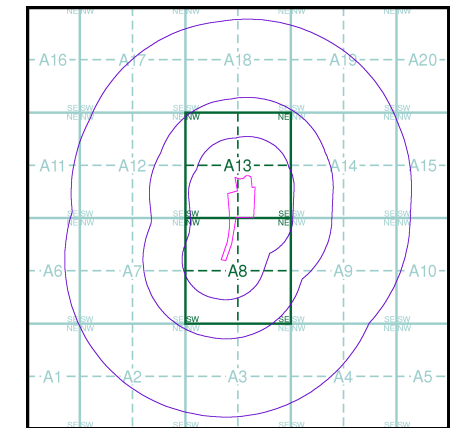

Order Details

Order Number: 41914630_1_1
 Customer Ref: 12044
 National Grid Reference: 331690, 189280
 Slice: A
 Site Area (Ha): 4.52
 Search Buffer (m): 1000

Site Details

Herbert Road, NEWPORT, Gwent, NP19 7BH

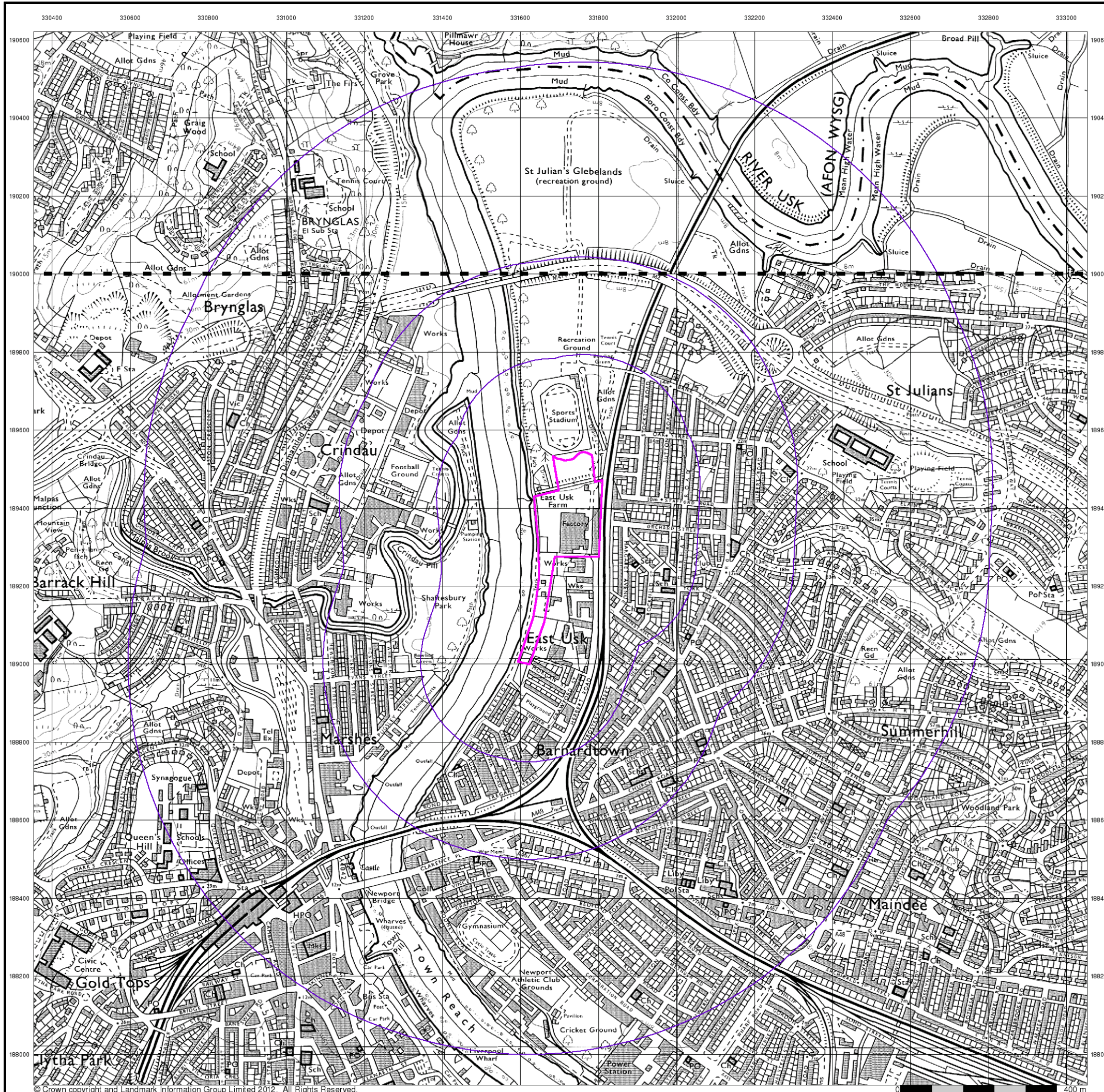



Ordnance Survey Plan

Published 1981 - 1983

Source map scale - 1:10,000

The historical maps shown were reproduced from maps predominantly held at the scale adopted for England, Wales and Scotland in the 1840's. In 1854 the 1:2,500 scale was adopted for mapping urban areas; these maps were used to update the 1:10,560 maps. The published date given therefore is often some years later than the surveyed date. Before 1938, all OS maps were based on the Cassini Projection, with independent surveys of a single county or group of counties, giving rise to significant inaccuracies in outlying areas. In the late 1940's, a Provisional Edition was produced, which updated the 1:10,560 mapping from a number of sources. The maps appear unfinished - with all military camps and other strategic sites removed. These maps were initially overprinted with the National Grid. In 1970, the first 1:10,000 maps were produced using the Transverse Mercator Projection. The revision process continued until recently, with new editions appearing every 10 years or so for urban areas.

Map Name(s) and Date(s)

| | | |
|--------|------|----------|
| ST39SW | 1983 | 1:10,000 |
| ST38NW | 1981 | 1:10,000 |

Historical Map - Slice A

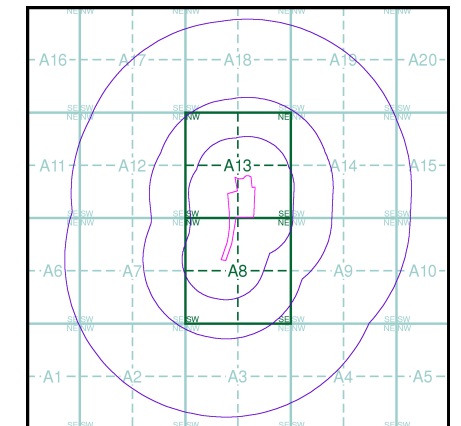

Order Details

Order Number: 41914630_1_1
 Customer Ref: 12044
 National Grid Reference: 331690, 189280
 Slice: A
 Site Area (Ha): 4.52
 Search Buffer (m): 1000

Site Details

Herbert Road, NEWPORT, Gwent, NP19 7BH



Tel: 0844 844 9952
 Fax: 0844 844 9951
 Web: www.envirocheck.co.uk





Newport

Published 1983

Source map scale - 1:10,000

These maps were produced by the Russian military during the Cold War between 1950 and 1997, and cover 103 towns and cities throughout the U.K. The maps are produced at 1:25,000, 1:10,000 and 1:5,000 scale, and show detailed land use, with colour-coded areas for development, green areas, and non-developed areas. Buildings are coloured black and important building uses (such as hospitals, post offices, factories etc.) are numbered, with a numbered key describing their use.

They were produced by the Russians for the benefit of navigation, as well as strategic military sites and transport hubs, for use if they were to have invaded the U.K. The detailed information provided indicates that the areas were surveyed using land-based personnel, on the ground, in the cities that are mapped.

Map Name(s) and Date(s)

ST39 SW
1983
1:10,000

ST38 NW
1983
1:10,000

Russian Map - Slice A

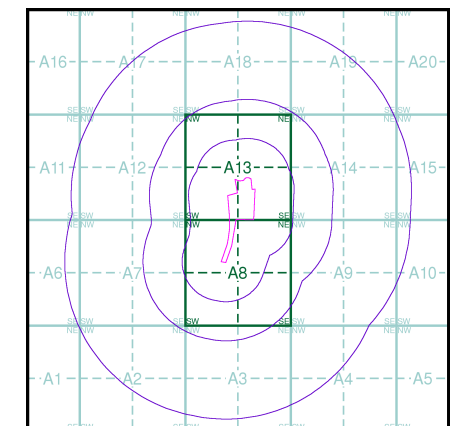

Order Details

Order Number: 41914630_1_1
Customer Ref: 12044
National Grid Reference: 331690, 189280
Slice: A
Site Area (Ha): 4.52
Search Buffer (m): 1000

Site Details

Herbert Road, NEWPORT, Gwent, NP19 7BH



Tel: 0844 844 9952
Fax: 0844 844 9951
Web: www.envirocheck.co.uk

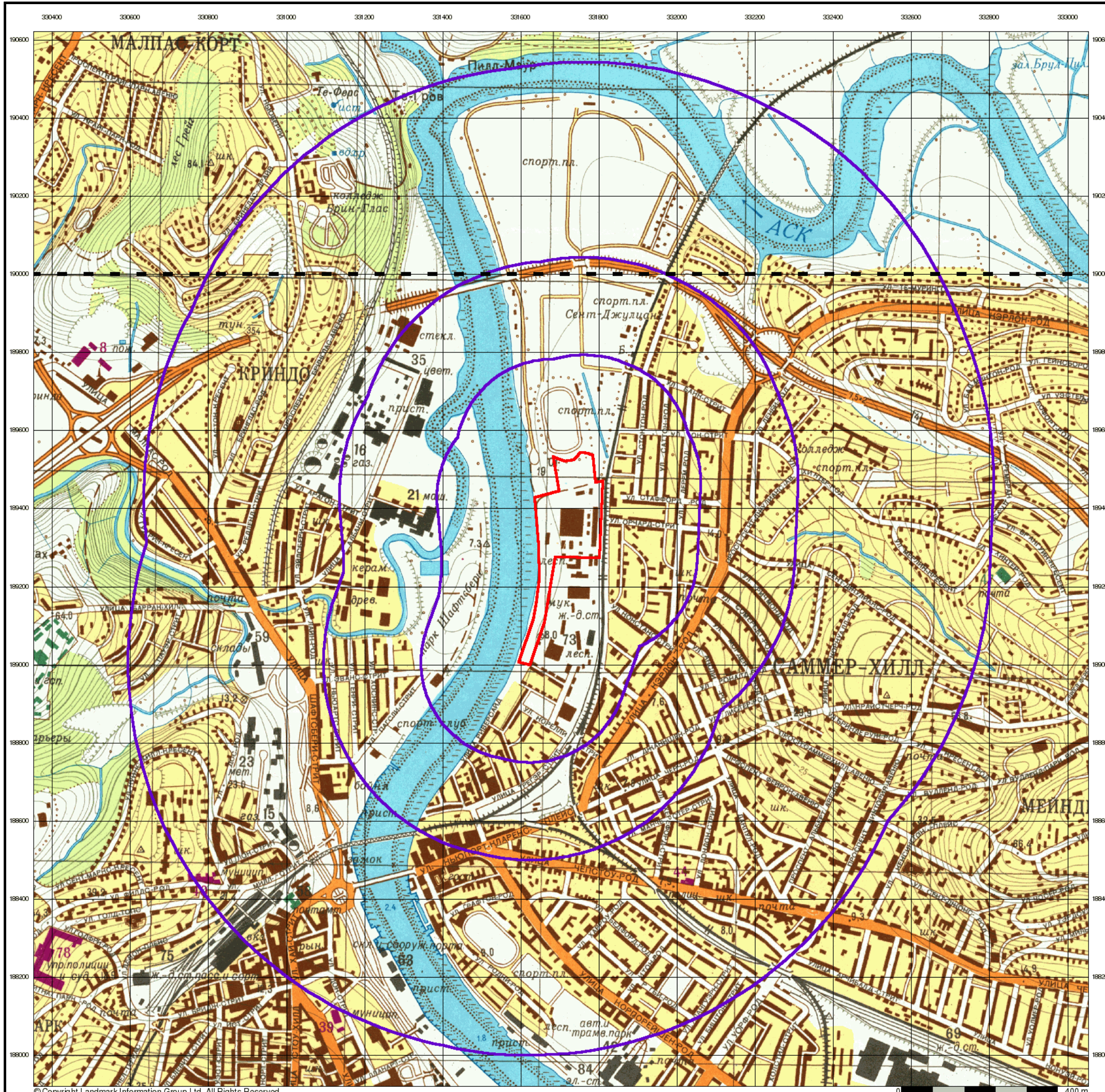



Ordnance Survey Plan

Published 1987

Source map scale - 1:10,000

The historical maps shown were reproduced from maps predominantly held at the scale adopted for England, Wales and Scotland in the 1840's. In 1854 the 1:2,500 scale was adopted for mapping urban areas; these maps were used to update the 1:10,560 maps. The published date given therefore is often some years later than the surveyed date. Before 1938, all OS maps were based on the Cassini Projection, with independent surveys of a single county or group of counties, giving rise to significant inaccuracies in outlying areas. In the late 1940's, a Provisional Edition was produced, which updated the 1:10,560 mapping from a number of sources. The maps appear unfinished - with all military camps and other strategic sites removed. These maps were initially overprinted with the National Grid. In 1970, the first 1:10,000 maps were produced using the Transverse Mercator Projection. The revision process continued until recently, with new editions appearing every 10 years or so for urban areas.

Map Name(s) and Date(s)

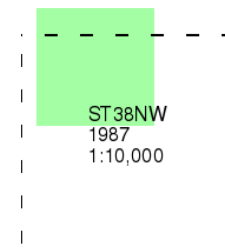

Historical Map - Slice A

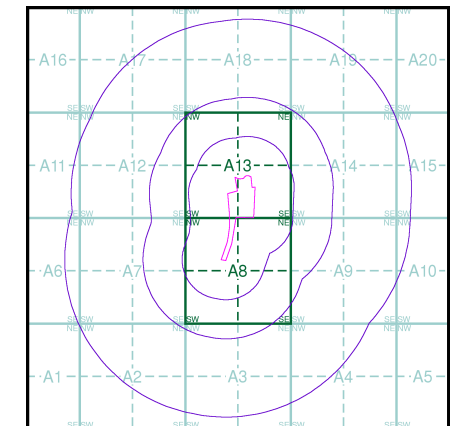

Order Details

Order Number: 41914630_1_1
Customer Ref: 12044
National Grid Reference: 331690, 189280
Slice: A
Site Area (Ha): 4.52
Search Buffer (m): 1000

Site Details

., Herbert Road, NEWPORT, Gwent, NP19 7BH



Tel: 0844 844 9952
Fax: 0844 844 9951
Web: www.envirocheck.co.uk

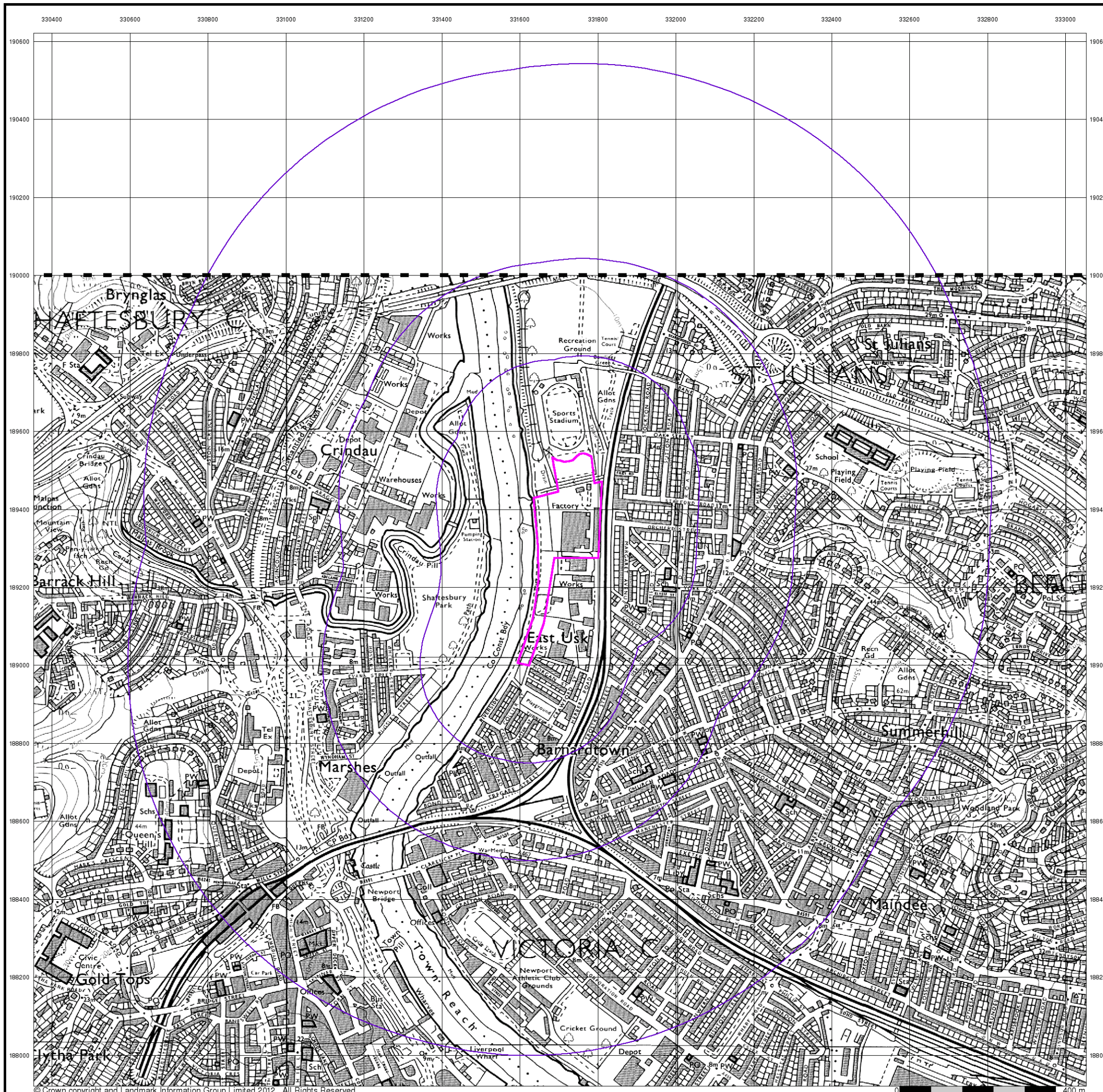

© Crown copyright and Landmark Information Group Limited 2012. All Rights Reserved.



10k Raster Mapping

Published 2006

Source map scale - 1:10,000

The historical maps shown were produced from the Ordnance Survey's 1:10,000 colour raster mapping. These maps are derived from Landplan which replaced the old 1:10,000 maps originally published in 1970. The data is highly detailed showing buildings, fences and field boundaries as well as all roads, tracks and paths. Road names are also included together with the relevant road number and classification. Boundary information depiction includes county, unitary authority, district, civil parish and constituency.

Map Name(s) and Date(s)

| | | |
|--------|------|----------|
| ST39SW | 2006 | 1:10,000 |
| ST38NW | 2006 | 1:10,000 |

Historical Map - Slice A

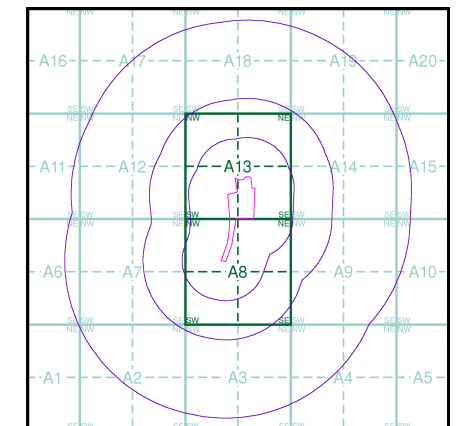

Order Details

Order Number: 41914630_1_1
 Customer Ref: 12044
 National Grid Reference: 331690, 189280
 Slice: A
 Site Area (Ha): 4.52
 Search Buffer (m): 1000

Site Details

Herbert Road, NEWPORT, Gwent, NP19 7BH



Tel: 0844 844 9952
 Fax: 0844 844 9951
 Web: www.envirocheck.co.uk

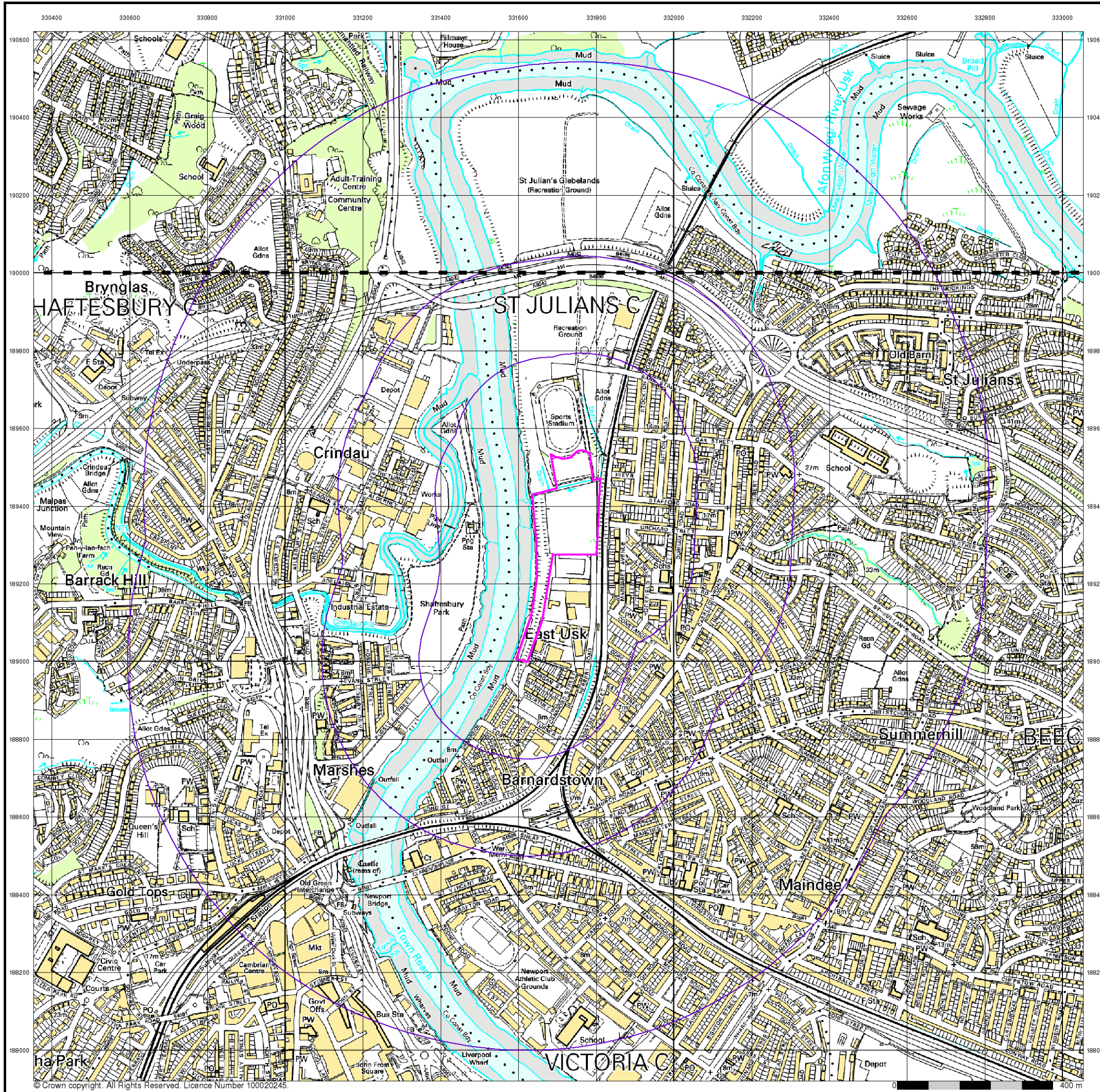

© Crown copyright. All Rights Reserved. Licence Number 100020245.



10k Raster Mapping

Published 2012

Source map scale - 1:10,000

The historical maps shown were produced from the Ordnance Survey's 1:10,000 colour raster mapping. These maps are derived from Landplan which replaced the old 1:10,000 maps originally published in 1970. The data is highly detailed showing buildings, fences and field boundaries as well as all roads, tracks and paths. Road names are also included together with the relevant road number and classification. Boundary information depiction includes county, unitary authority, district, civil parish and constituency.

Map Name(s) and Date(s)

| | | |
|--------|------|----------|
| ST39SW | 2012 | 1:10,000 |
| ST38NW | 2012 | 1:10,000 |

Historical Map - Slice A

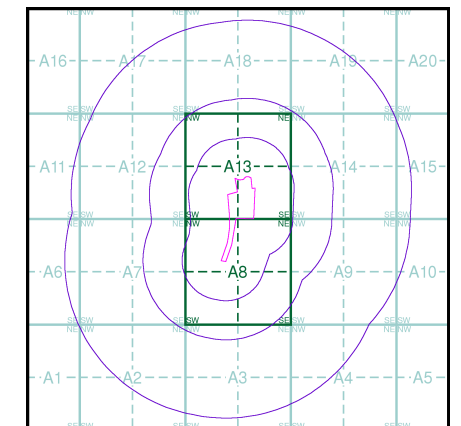

Order Details

| | |
|--------------------------|----------------|
| Order Number: | 41914630_1_1 |
| Customer Ref: | 12044 |
| National Grid Reference: | 331690, 189280 |
| Slice: | A |
| Site Area (Ha): | 4.52 |
| Search Buffer (m): | 1000 |

Site Details

Herbert Road, NEWPORT, Gwent, NP19 7BH



Tel: 0844 844 9952
 Fax: 0844 844 9951
 Web: www.envirocheck.co.uk

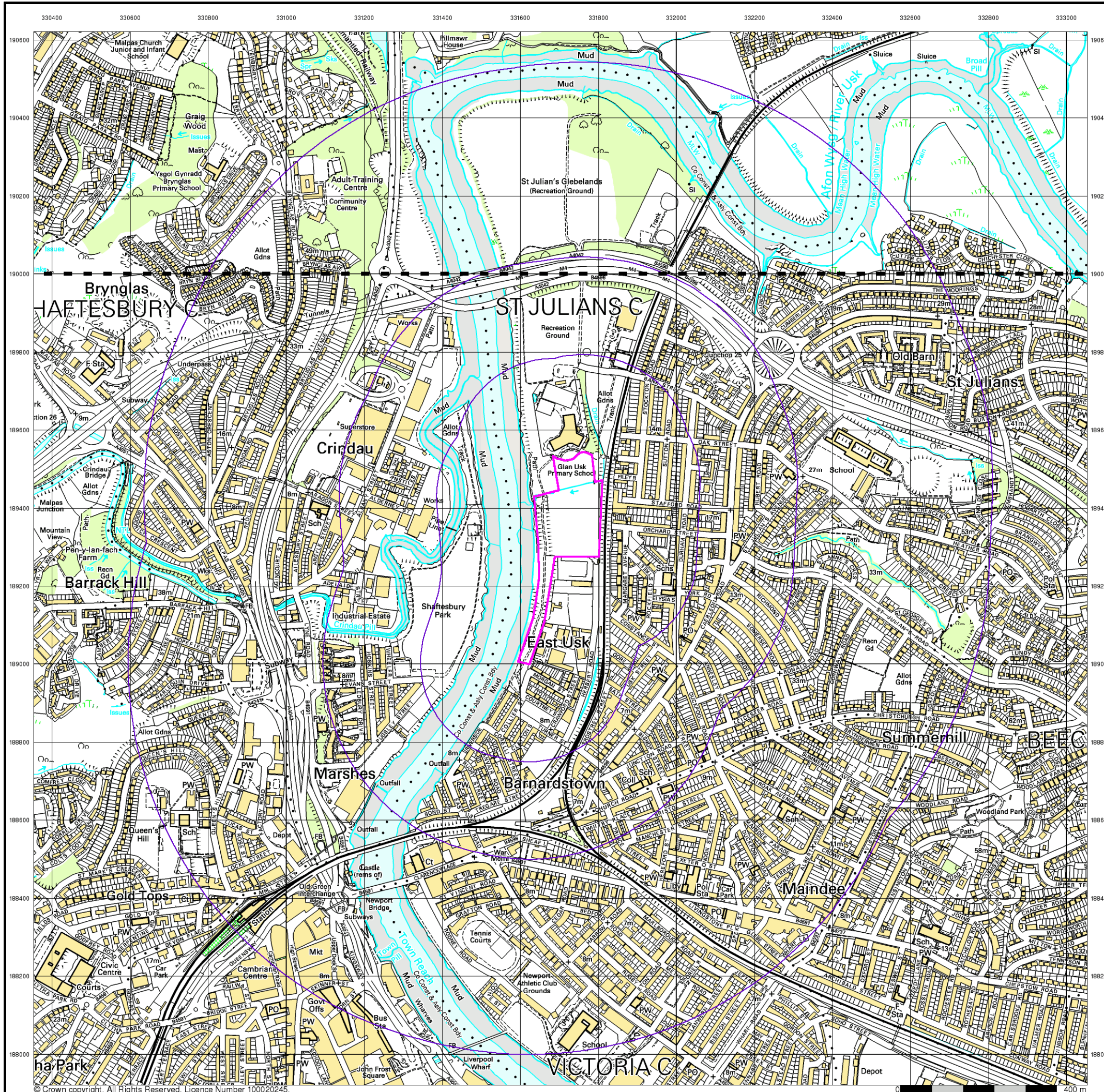

© Crown copyright. All Rights Reserved. Licence Number 100020245.

**ANNEX B
Radon Report**



**British
Geological Survey**
NATURAL ENVIRONMENT RESEARCH COUNCIL

GeoReports

**Helen Eddy
Terra Firma Wales Ltd
5 Deryn Court
Wharfedales Road
Pentwyn
Cardiff
CF38 1AA**

Radon Report: England and Wales

Advisory report on the requirement for radon protective measures in new buildings, conversions and extensions to existing buildings. The report also indicates whether a site is located within a radon Affected Area

Report Id: *GR_205477/1*

Client reference: 12044

Search location

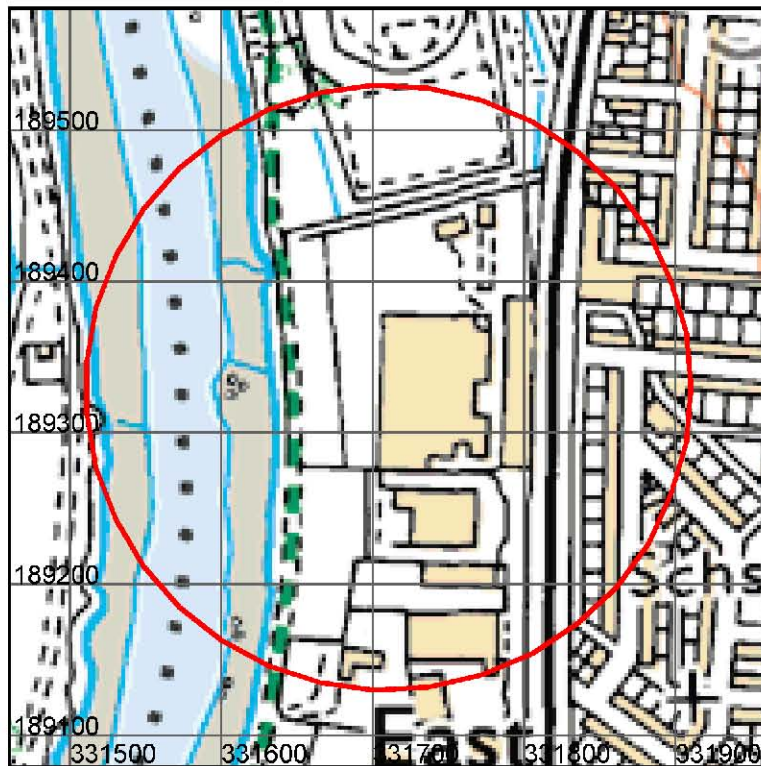

This report describes a site located at National Grid Reference 331710, 189330. Note that for sites of irregular shape, this point may lie outside the site boundary. Where the client has submitted a site plan the assessment will be based on the area given.

Search location indicated in red

This product includes mapping data licensed from Ordnance Survey.
© Crown Copyright and/or database right 2012. Licence number 100037272
Scale: 1:5 000 (1cm = 50 m)

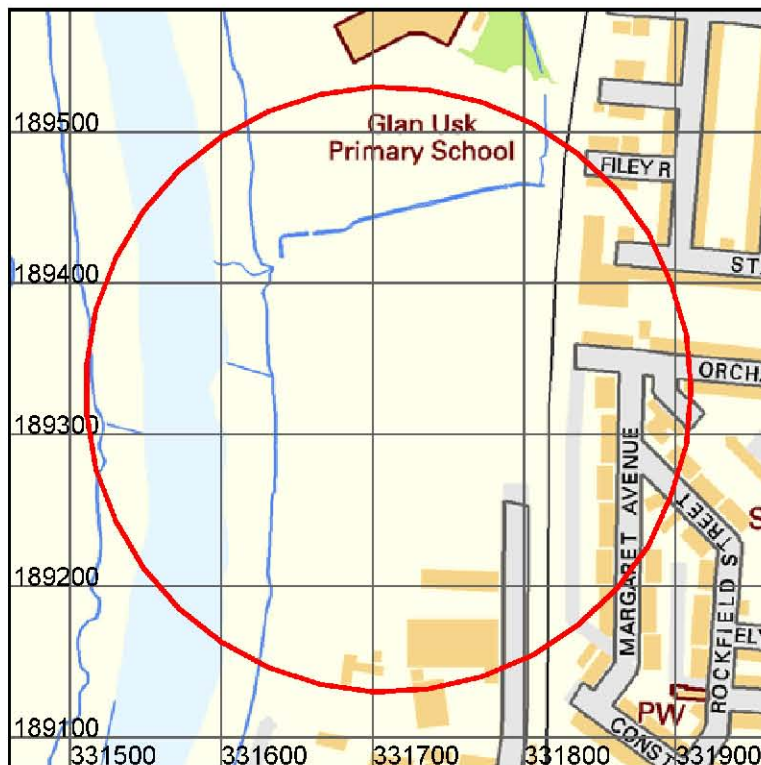

Contains Ordnance Survey data © Crown Copyright and database right 2012
OS Street View: Scale: 1:5 000 (1cm = 50 m)



Radon Report: England and Wales

This is an advisory report on the requirement for radon protective measures in new buildings, conversions and extensions. The report also indicates whether a site is located within a radon Affected Area

Requirement for radon protective measures

The determination below follows advice in *BR211 Radon: Guidance on protective measures for new buildings (2007 edition)*, which also provides guidance on what to do if the result indicates that protective measures are required.

BASIC RADON PROTECTIVE MEASURES ARE REQUIRED FOR THE REPORT AREA.

The BGS is not able to provide advice on the technical specifications of 'basic' and 'full' radon protective measures. This information is detailed in **BRE Report BR211 Radon: guidance on protective measures for new buildings** which may be purchased from brebookshop.com. This report offers guidance on the technical solutions that are required to satisfy Building Regulations requirements.

Technical solutions to radon protection in new build and existing dwellings in radon affected areas are available on the BRE web site at:

<http://www.bre.co.uk/page.jsp?id=1626> and <http://www.bre.co.uk/radon/> and in a range of technical reports available from brebookshop.com; Tel: 01923 664262, email: bookshop@bre.co.uk.

Summary guidance is available on the web at:

<http://www.bre.co.uk/radon/protect.html>.

If you require further information or guidance, you should contact your local authority building control officer or approved inspector.



Radon in existing buildings

Is this property in a radon affected area – **YES**

The answer to the standard enquiry on house purchase known as **CON29 Standard Enquiry of Local Authority 3.13 Radon Gas: Location of the Property in a radon Affected Area** is **YES** this property is in a Radon Affected Area as defined by the Health Protection Agency (HPA).

The estimated probability of the property being above the Action Level for radon is: **5-10% (INTERMEDIATE PROBABILITY)**.

The result informs you of the estimated probability that this particular property is above the Action Level for radon. This does not necessarily mean there is a radon problem in the property. The only way to determine whether it is above or below the Action Level is to carry out a radon measurement within the existing property.

Radon Affected Areas are designated by the HPA. They advise that radon gas should be measured in all properties within Radon Affected Areas.

If you are buying a new build property in a Radon Affected Area, you should ask the builder whether radon protective measures were incorporated in the construction of the property.

If you are buying a currently occupied property in a Radon Affected Area you should ask the present owner whether radon levels have been measured in the property. If they have, ask whether the results were above the Radon Action Level and if so whether remedial measures were installed, radon levels were retested, and that the results of re-testing confirmed the effectiveness of the measures.

In radon affected homes, the problem of radon can usually be tackled with simple, effective and relatively inexpensive measures. These measures are comparable in cost to work such as damp-proofing and timber treatment. You can get practical advice about construction work to reduce radon levels from the Building Control Officer at your local council.

For further information, advice about radon, its health risks and details of how to order the radon test, please contact the HPA Radon Helpline on 01235 822622 or go online at www.ukradon.org or write to Radon Survey, Health Protection Agency, Centre for Radiation, Chemical and Environmental Hazards, Chilton, Didcot, Oxon, OX11 0RQ, email: radon@hpa.org.uk. You can obtain an information pack from the HPA free Radon answerphone on 0800 614529



What is radon?

Radon is a naturally occurring radioactive gas, which is produced by the radioactive decay of radium which, in turn, is derived from the radioactive decay of uranium. Uranium is found in small quantities in all soils and rocks, although the amount varies from place to place. Radon released from rocks and soils is quickly diluted in the atmosphere. Concentrations in the open air are normally very low and do not present a hazard. Radon that enters enclosed spaces such as some buildings (particularly basements), caves, mines, and tunnels may reach high concentrations in some circumstances. The construction method and degree of ventilation will influence radon levels in individual buildings. A person's exposure to radon will also vary according to how particular buildings and spaces are used.

Inhalation of the radioactive decay products of radon gas increases the chance of developing lung cancer. If individuals are exposed to high concentrations for significant periods of time, there may be cause for concern. In order to limit the risk to individuals, the Government has adopted an Action Level for radon in homes of 200 becquerels per cubic metre (Bq m^{-3}). The Government advises householders that, where the radon level exceeds the Action Level, measures should be taken to reduce the concentration.

Radon in workplaces

The Ionising Radiation Regulations, 1999, require employers to take action when radon is present above a defined level in the workplace. Advice may be obtained from your local Health and Safety Executive Area Office or the Environmental Health Department of your local authority. The BRE publishes a guide (BR293): **Radon in the workplace**. BRE publications may be obtained from the BRE Bookshop, Tel: 01923 664262, email: bookshop@bre.co.uk website: www.brebookshop.com



Contact Details

Keyworth (KW) Office

British Geological Survey
Kingsley Dunham Centre
Keyworth
Nottingham
NG12 5GG
Tel: 0115 9363143
Fax: 0115 9363276
Email: enquiries@bgs.ac.uk

Wallingford (WL) Office

British Geological Survey
Maclean Building
Wallingford
Oxford
OX10 8BB
Tel: 01491 838800
Fax: 01491 692345
Email: hydroenq@bgs.ac.uk

Murchison House (MH) Office

British Geological Survey
Murchison House
West Mains Road
Edinburgh
EH9 3LA
Tel: 0131 650 0282
Fax: 0131 650 0252
Email: enquiry@bgs.ac.uk



Terms and Conditions

General Terms & Conditions

This Report is supplied in accordance with the GeoReports Terms & Conditions available on the BGS website at www.bgs.ac.uk/georeports and also available from the BGS Central Enquiries Desk at the above address.

Important notes about this Report

- The data, information and related records supplied in this Report by BGS can only be indicative and should not be taken as a substitute for specialist interpretations, professional advice and/or detailed site investigations. You must seek professional advice before making technical interpretations on the basis of the materials provided.
- Geological observations and interpretations are made according to the prevailing understanding of the subject at the time. The quality of such observations and interpretations may be affected by the availability of new data, by subsequent advances in knowledge, improved methods of interpretation, and better access to sampling locations.
- Raw data may have been transcribed from analogue to digital format, or may have been acquired by means of automated measuring techniques. Although such processes are subjected to quality control to ensure reliability where possible, some raw data may have been processed without human intervention and may in consequence contain undetected errors.
- Detail, which is clearly defined and accurately depicted on large-scale maps, may be lost when small-scale maps are derived from them.
- Although samples and records are maintained with all reasonable care, there may be some deterioration in the long term.
- The most appropriate techniques for copying original records are used, but there may be some loss of detail and dimensional distortion when such records are copied.
- Data may be compiled from the disparate sources of information at BGS's disposal, including material donated to BGS by third parties, and may not originally have been subject to any verification or other quality control process.
- Data, information and related records, which have been donated to BGS, have been produced for a specific purpose, and that may affect the type and completeness of the data recorded and any interpretation. The nature and purpose of data collection, and the age of the resultant material may render it unsuitable for certain applications/uses. You must verify the suitability of the material for your intended usage.
- If a report or other output is produced for you on the basis of data you have provided to BGS, or your own data input into a BGS system, please do not rely on it as a source of information about other areas or geological features, as the report may omit important details.
- The topography shown on any map extracts is based on the latest OS mapping and is not necessarily the same as that used in the original compilation of the BGS geological map, and to which the geological linework available at that time was fitted.
- Note that for some sites, the latest available records may be quite historical in nature, and while every effort is made to place the analysis in a modern geological context, it is possible in some cases that the detailed geology at a site may differ from that described.

Copyright:

Copyright in materials derived from the British Geological Survey's work, is owned by the Natural Environment Research Council (NERC) and/ or the authority that commissioned the work. You may not copy or adapt this publication, or provide it to a third party, without first obtaining NERC's permission, but if you are a consultant purchasing this report solely for the purpose of providing advice to your own individual client you may incorporate it unaltered into your report to that client without further permission, provided you give a full acknowledgement of the source. Please contact the BGS Copyright Manager, British Geological Survey, Kingsley Dunham Centre, Keyworth, Nottingham NG12 5GG. Telephone: 0115 936 3100.

© NERC 2012 All rights reserved.

This product includes mapping data licensed from the Ordnance Survey® with the permission of the Controller of Her Majesty's Stationery Office. © Crown Copyright 2012. All rights reserved. Licence number 100037272



**Report issued by
BGS Enquiry Service**

ANNEX C
Risk Assessment Definitions

Risk Assessment Definitions

Environmental risk assessment evaluates the risk to receptors via an analysis of the 'source-pathway-receptor' linkage.

- (1) A **CONTAMINANT** (hazard) - a substance that is in, on or under the land and has the potential to cause harm or to cause pollution of controlled waters
- (2) A **RECEPTOR** (target) - something which could be adversely affected by a contaminant
- (3) A **PATHWAY** - a route or means which either allows the contaminant to cause significant harm to that receptor, or that there is a significant possibility of such harm being caused to the receptor, or that pollution of controlled waters is being or likely to be caused.

The term 'Risk' is widely used in different contexts and situations, but a prescriptive definition is given by the Guidelines for Environmental Risk Assessment and Management (DEFRA *et al*, 2000):

'Risk is a combination of the probability, or frequency, of occurrence of a defined hazard and the magnitude of the consequences of the occurrence'.

A 'Hazard' is defined as 'a property or situation that in particular circumstances could lead to harm'.

The classification of consequences and probability and determining the risk category are defined in the following sections.

| Table 1 Classification of Consequence | |
|--|--|
| Classification | Definition |
| Severe | <ul style="list-style-type: none"> • Short term (acute) risk to human health likely to result in significant harm • Short term risk to controlled waters • Catastrophic damage to buildings/structures • Short term risk to an ecosystem or organism within the particular ecosystem |
| Medium | <ul style="list-style-type: none"> • Chronic damage to human health (long term risk) • Pollution of a sensitive water resource • A significant change in an ecosystem or organism within the ecosystem |
| Mild | <ul style="list-style-type: none"> • Pollution of non-sensitive water resources • Significant damage to buildings/structures |
| Negligible | <ul style="list-style-type: none"> • Harm (not necessarily significant) which may result in financial loss • Non permanent health effects to humans (easily prevented by PPE for example) • Easily repairable effects of structural (building) damage |

| Table 2 Classification of Probability | |
|--|--|
| Classification | Definition |
| High | <ul style="list-style-type: none"> • There is a complete pollution linkage and an event appears very likely to occur in the short term and is inevitable in the long term. • Evidence of harm to the receptor |
| Medium | <ul style="list-style-type: none"> • There is a complete pollution linkage which means that it is probable that an event will occur • The event is not inevitable but possible in short term and likely in the long term |
| Low | <ul style="list-style-type: none"> • There is a complete pollution linkage and circumstances are possible under which an event could occur • It is not certain that an event will occur in the long term, and it is less likely to occur in the short term |
| Negligible | <ul style="list-style-type: none"> • There is a complete pollution linkage but circumstances are such that it is improbable that an event would occur even in the long term |

By comparing the consequences of a risk and the probability of the risk of a pollution linkage, the likely risk category can be determined as shown in **Table 3** below.

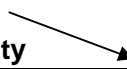
| Table 3 Risk Assessment Matrix | | | | | |
|---|-------------------|---------------------|---------------|--------------|-------------------|
| Increasing acceptability  | | Consequence | | | |
| | | Severe | Medium | Mild | Negligible |
| Probability | High | High | High | Medium / Low | Near zero |
| | Medium | High | Medium | Low | Near zero |
| | Low | High / medium | Medium / Low | Low | Near zero |
| | Negligible | High / medium / Low | Medium / Low | Low | Near zero |

High Risk

There is a high probability that severe harm could risk a receptor, or there is evidence that a receptor is being harmed. The risk if realised is likely to result in liability, and urgent investigation or remediation will be required.

Medium Risk

It is probable that harm will arise to a receptor. However it is relatively unlikely that such harm would be severe, or if harm does occur the harm is likely to be relatively mild. Investigation will be required to determine the liability, and some remedial works may be required in the long term.

Low Risk

It is possible that harm may arise to a receptor, but it is likely that the harm would be mild.

Near Zero Risk

There is a very low risk of harm to the receptor. In the event of harm being realised the harm is

ANNEX D
Trial Pit Logs



Tel: 02920 735354
 info@terrafirmawales.co.uk
 www.terrafirmawales.co.uk

Terra Firma (Wales) Limited
 5 Deryn Court, Wharfedale Road
 Pentwyn, Cardiff
 CF23 7HA

Trial Pit No:
TP1
 Sheet 1 of 1

Project Name: Herbert Road Phase 1 Project No: 12032P1 Co-ords: -
 Level: Date: 27/01/2017

Location: Newport Dimensions: Scale: 1:25
 Client: Keepmoat Depth 1.20 Logged: RH

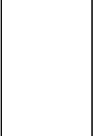
| Water Strike | Samples & In Situ Testing | | | Depth (m) | Level (m) | Legend | Stratum Description |
|--------------|---------------------------|------|---------|-----------|-----------|---|---|
| | Depth | Type | Results | | | | |
| | 1.30 | D | | 1.20 | |  | MADE GROUND: grey slightly clayey SAND and GRAVEL and COBBLE including brick, and concrete. Paving slab, metal wire, plastic and occasional concrete boulder. |
| | | | | | | | End of Pit at 1.200m |

Stability:

Remarks: Trial pit terminated at 1.2m due to presence of probable large concrete boulder



Tel: 02920 735354
 info@terrafirmawales.co.uk
 www.terrafirmawales.co.uk

Terra Firma (Wales) Limited
 5 Deryn Court, Wharfedale Road
 Pentwyn, Cardiff
 CF23 7HA

Trial Pit No:
TP2
 Sheet 1 of 1

Project Name: Herbert Road Phase 1 Project No: 12032P1 Co-ords: - Date: 27/01/2017
 Level: Scale: 1:25

Location: Newport Dimensions: Logged: RH
 Client: Keepmoat Depth: 1.80

| Water Strike | Samples & In Situ Testing | | | Depth (m) | Level (m) | Legend | Stratum Description |
|--------------|---------------------------|------|---------|-----------|-----------|--------|--|
| | Depth | Type | Results | | | | |
| | | | | 0.30 | | | MADE GROUND: Soft dark brown gravelly CLAY. Brick fragments. |
| | 0.60 | D | | | | | MADE GROUND: Firm red and grey gravelly CLAY. Gravel is fine to coarse angular to sub-rounded of sandstone, mudstone, slate and brick. |
| | | | | 1.50 | | | MADE GROUND: Very soft grey sandy gravelly CLAY |
| | | | | 1.60 | | | Firm grey brown silty CLAY |
| | | | | 1.80 | | | End of Pit at 1.800m |

Stability:

Remarks:



Tel: 02920 735354
 info@terrafirmawales.co.uk
 www.terrafirmawales.co.uk

Terra Firma (Wales) Limited
 5 Deryn Court, Wharfedale Road
 Pentwyn, Cardiff
 CF23 7HA

Trial Pit No:
TP3
 Sheet 1 of 1

Project Name: Herbert Road Phase 1 Project No: 12032P1 Co-ords: -
 Level: Date: 27/01/2017

Location: Newport Dimensions: Scale: 1:25
 Client: Keepmoat Depth: 1.30 Logged: RH

| Water Strike | Samples & In Situ Testing | | | Depth (m) | Level (m) | Legend | Stratum Description |
|--------------|---------------------------|------|---------|-----------|-----------|--------|--|
| | Depth | Type | Results | | | | |
| | 0.20 | D | | 0.40 | | | MADE GROUND: Dark grey SAND and GRAVEL and COBBLE. Brick, concrete, china and timber. |
| | | | | 0.90 | | | MADE GROUND: Probably loose grey and grey brown clayey SAND and GRAVEL. Brick and slate. |
| | | | | 1.30 | | | Firm grey silty CLAY |
| | | | | | | | End of Pit at 1.300m |

Stability:

Remarks:



Tel: 02920 735354
 info@terrafirmawales.co.uk
 www.terrafirmawales.co.uk

Terra Firma (Wales) Limited
 5 Deryn Court, Wharfedale Road
 Pentwyn, Cardiff
 CF23 7HA

Trial Pit No:
TP4
 Sheet 1 of 1

Project Name: Herbert Road Phase 1 Project No: 12032P1 Co-ords: - Date: 27/01/2017
 Level: Scale: 1:25

Location: Newport Dimensions: 
 Client: Keepmoat Depth: 1.20 Logged: RH

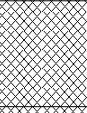
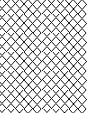
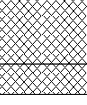
| Water Strike | Samples & In Situ Testing | | | Depth (m) | Level (m) | Legend | Stratum Description |
|--------------|---------------------------|------|---------|-----------|-----------|---|---|
| | Depth | Type | Results | | | | |
| | | | | 0.15 | |  | MADE GROUND: Soft dark brown sandy CLAY. |
| | 0.50 | D | | 0.50 | |  | MADE GROUND: Loose grey clayey SAND and fine to coarse angular GRAVEL and COBBLE. Rare glass, brick and timber. |
| | | | | 1.10 | |  | MADE GROUND: Stiff red gravelly CLAY. Gravel is fine to coarse angular to sub-angular of red mudstone (re-worked natural) |
| | | | | 1.20 | |  | MADE GROUND: Very dense grey clayey GRAVEL and COBBLE. Occasional boulder. End of Pit at 1.200m |

Stability:

Remarks:



Tel: 02920 735354
 info@terrafirmawales.co.uk
 www.terrafirmawales.co.uk

Terra Firma (Wales) Limited
 5 Deryn Court, Wharfedale Road
 Pentwyn, Cardiff
 CF23 7HA

Trial Pit No:
TP5
 Sheet 1 of 1

| | | | |
|------------------------------------|---------------------|----------------------|------------------|
| Project Name: Herbert Road Phase 1 | Project No: 12032P1 | Co-ords: - Level: | Date: 27/01/2017 |
|------------------------------------|---------------------|----------------------|------------------|

| | | |
|-------------------|---|-------------|
| Location: Newport | Dimensions: <div style="border: 1px solid black; width: 100px; height: 20px; display: inline-block;"></div> | Scale: 1:25 |
| Client: Keepmoat | Depth: 2.70 | Logged: RH |

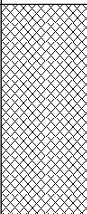
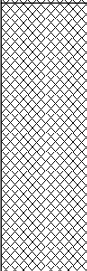
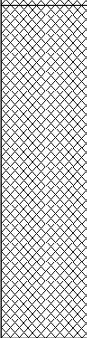
| Water Strike | Samples & In Situ Testing | | | Depth (m) | Level (m) | Legend | Stratum Description |
|--------------|---------------------------|------|---------|-----------|-----------|--|---|
| | Depth | Type | Results | | | | |
| | 0.30 | D | | 0.70 | |  | MADE GROUND: Firm grey brown gravelly cobbly CLAY. Gravel and cobble are fine to coarse angular to sub-angular of sandstone, mudstone, brick and concrete. Occasional plastic sheeting. |
| | | | | 1.60 | |  | MADE GROUND: Probably medium dense becoming loose grey slightly clayey SAND and fine to coarse angular to sub-rounded GRAVEL. Plastic, metal, fabric. |
| | | | | 2.70 | |  | MADE GROUND: Firm with soft inclusions grey and brown mottled CLAY. Slightly ashy in places |
| | | | | | | | End of Pit at 2.700m |

Stability:

Remarks:



Tel: 02920 735354
 info@terrafirmawales.co.uk
 www.terrafirmawales.co.uk

Terra Firma (Wales) Limited
 5 Deryn Court, Wharfedale Road
 Pentwyn, Cardiff
 CF23 7HA

Trial Pit No:
TP6
 Sheet 1 of 1

Project Name: Herbert Road Phase 1 Project No: 12032P1 Co-ords: - Date: 27/01/2017
 Level: Scale: 1:25

Location: Newport Dimensions: Logged: RH
 Client: Keepmoat Depth: 1.80

| Water Strike | Samples & In Situ Testing | | | Depth (m) | Level (m) | Legend | Stratum Description |
|--------------|---------------------------|------|---------|-----------|-----------|--------|---|
| | Depth | Type | Results | | | | |
| | | | | 0.10 | | | MADE GROUND: Soft dark brown CLAY |
| | 0.40 | D | | | | | MADE GROUND: Probably loose brown clayey sandy GRAVEL. Bricks, concrete, plastic, red plastic pipe, red tile fragments. Rare timber. Fragments of corrugated cement sheeting containing asbestos) |
| | | | | 1.30 | | | MADE GROUND: Loose dark grey ashy gravelly SAND. Fragments of brick and plastic. |
| | | | | 1.80 | | | End of Pit at 1.800m |

Stability:

Remarks:



Tel: 02920 735354
 info@terrafirmawales.co.uk
 www.terrafirmawales.co.uk

Terra Firma (Wales) Limited
 5 Deryn Court, Wharfedale Road
 Pentwyn, Cardiff
 CF23 7HA

Trial Pit No:
TP7
 Sheet 1 of 1

Project Name: Herbert Road Phase 1 Project No: 12032P1 Co-ords: - Date: 27/01/2017
 Level: Level:

Location: Newport Dimensions: Scale: 1:25
 Client: Keepmoat Depth 1.30 Logged: RH

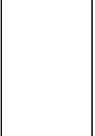
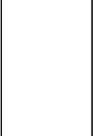
| Water Strike | Samples & In Situ Testing | | | Depth (m) | Level (m) | Legend | Stratum Description |
|--------------|---------------------------|------|---------|-----------|-----------|---|---|
| | Depth | Type | Results | | | | |
| | 0.20 | D | | 0.30 | |  | MADE GROUND: Soft grey CLAY. |
| | | | | 1.30 | |  | MADE GROUND: Firm red and grey gravelly CLAY. Occasional small boulder. Bricks and concrete fragments. |
| | | | | | | | End of Pit at 1.300m |

Stability:
 Remarks: Trial pit terminated at 1.3m due to presence of probable large concrete boulder



Tel: 02920 735354
 info@terrafirmawales.co.uk
 www.terrafirmawales.co.uk

Terra Firma (Wales) Limited
 5 Deryn Court, Wharfedale Road
 Pentwyn, Cardiff
 CF23 7HA

Trial Pit No:
TP8
 Sheet 1 of 1

Project Name: Herbert Road Phase 1 Project No: 12032P1 Co-ords: -
 Level: Date: 27/01/2017

Location: Newport Dimensions: Scale: 1:25
 Client: Keepmoat Depth 0.80 Logged: RH

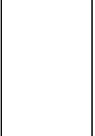
| Water Strike | Samples & In Situ Testing | | | Depth (m) | Level (m) | Legend | Stratum Description |
|--------------|---------------------------|------|---------|-----------|-----------|---|---|
| | Depth | Type | Results | | | | |
| | 0.60 | D | | 0.80 | |  | MADE GROUND: Probably loose red and grey very clayey SAND and fine to coarse angular GRAVEL and COBBLE. Brick fragments and occasional glass. |
| | | | | | | | End of Pit at 0.800m |



Stability:

Remarks:



Tel: 02920 735354
 info@terrafirmawales.co.uk
 www.terrafirmawales.co.uk

Terra Firma (Wales) Limited
 5 Deryn Court, Wharfedale Road
 Pentwyn, Cardiff
 CF23 7HA

Trial Pit No:
TP9
 Sheet 1 of 1

Project Name: Herbert Road Phase 1 Project No: 12032P1 Co-ords: -
 Level: Date: 27/01/2017

Location: Newport Dimensions: Scale: 1:25
 Client: Keepmoat Depth 0.70 Logged: RH

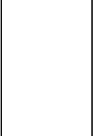
| Water Strike | Samples & In Situ Testing | | | Depth (m) | Level (m) | Legend | Stratum Description |
|--------------|---------------------------|------|---------|-----------|-----------|---|---|
| | Depth | Type | Results | | | | |
| | 0.40 | D | | 0.70 | |  | MADE GROUND: Probably loose red and grey very clayey SAND and fine to coarse angular GRAVEL and COBBLE. Brick fragments and occasional glass. |
| | | | | | | | End of Pit at 0.700m |



Stability:

Remarks:



Tel: 02920 735354
 info@terrafirmawales.co.uk
 www.terrafirmawales.co.uk

Terra Firma (Wales) Limited
 5 Deryn Court, Wharfedale Road
 Pentwyn, Cardiff
 CF23 7HA

Trial Pit No:
TP10
 Sheet 1 of 1

Project Name: Herbert Road Phase 1 Project No: 12032P1 Co-ords: -
 Level: Date: 27/01/2017

Location: Newport Dimensions: Scale: 1:25
 Client: Keepmoat Depth 1.10 Logged: RH

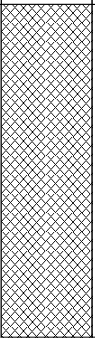
| Water Strike | Samples & In Situ Testing | | | Depth (m) | Level (m) | Legend | Stratum Description |
|--------------|---------------------------|------|---------|-----------|-----------|---|--|
| | Depth | Type | Results | | | | |
| | 0.20 | D | | 1.10 | |  | MADE GROUND: Probably loose dark grey clayey SAND and fine to coarse angular GRAVEL and COBBLE. Brick, concrete, china, glass. |
| | | | | | | | |

Stability:

Remarks:



Tel: 02920 735354
 info@terrafirmawales.co.uk
 www.terrafirmawales.co.uk

Terra Firma (Wales) Limited
 5 Deryn Court, Wharfedale Road
 Pentwyn, Cardiff
 CF23 7HA

Trial Pit No:
TP11
 Sheet 1 of 1

Project Name: Herbert Road Phase 1 Project No: 12032P1 Co-ords: - Date: 27/01/2017
 Level: Level:

Location: Newport Dimensions: Scale: 1:25
 Client: Keepmoat Depth: 2.10 Logged: RH

| Water Strike | Samples & In Situ Testing | | | Depth (m) | Level (m) | Legend | Stratum Description |
|--------------|---------------------------|------|---------|-----------|-----------|--------|---|
| | Depth | Type | Results | | | | |
| | 0.50 | D | | 0.90 | | | MADE GROUND: Probably loose to medium dense grey, red and brown slightly clayey SAND and GRAVEL and COBBLE. Slate, brick, glassy slag, glass. |
| | | | | 1.70 | | | MADE GROUND: Probably loose dark grey ashy SAND and GRAVEL. Brick, plastic, slate, red tarmac, occasional timber. |
| | | | | 2.10 | | | MADE GROUND: Dense pink brown SAND and fine to coarse angular GRAVEL. Brick fragments. |
| | | | | | | | End of Pit at 2.100m |

Stability:

Remarks: Ground conditions too dense to excavate to a greater depth



Tel: 02920 735354
 info@terrafirmawales.co.uk
 www.terrafirmawales.co.uk

Terra Firma (Wales) Limited
 5 Deryn Court, Wharfedale Road
 Pentwyn, Cardiff
 CF23 7HA

Trial Pit No:
TP12
 Sheet 1 of 1

Project Name: Herbert Road Phase 1 Project No: 12032P1 Co-ords: - Date: 27/01/2017
 Level: Scale: 1:25

Location: Newport Dimensions: Logged: RH
 Client: Keepmoat Depth 3.00

| Water Strike | Samples & In Situ Testing | | | Depth (m) | Level (m) | Legend | Stratum Description |
|--------------|---------------------------|------|---------|-----------|-----------|--------|---|
| | Depth | Type | Results | | | | |
| | 0.30 | D | | | | | MADE GROUND: Probably dense brown SAND and fine to coarse angular to sub-angular GRAVEL o sandstone and slag. Occasional brick fragments. Terram fragments. Concrete boulder roughly 1.0m x 0.4m x 0.15m in size. |
| | | | | 1.40 | | | MADE GROUND: Soft red and grey gravelly CLAY. Wire, brick. |
| | | | | 2.70 | | | MADE GROUND: Soft grey silty CLAY. Rare china and coal fragment. |
| | | | | 3.00 | | | End of Pit at 3.000m |

Stability:

Remarks:

**ANNEX E
Borehole Logs**



Tel: 02920 735354
 info@terrafirmawales.co.uk
 www.terrafirmawales.co.uk

Terra Firma (Wales) Limited
 5 Deryn Court, Wharfedale Road
 Pentwyn, Cardiff
 CF23 7HA

Borehole No.

BH1

Sheet 1 of 2

| | | | |
|------------------------------------|---------------------|----------|--------------|
| Project Name: Herbert Road Phase 1 | Project No: 12032P1 | Co-ords: | Hole Type CP |
| Location: Newport | Level: | | Scale 1:54 |
| Client: Keepmoat | Dates: 08/02/2017 - | | Logged By |

| Water Strikes | Sample and In Situ Testing | | | Depth (m) | Level (m) | Well | Legend | Stratum Description | |
|---------------|----------------------------|------|--------------------|-----------|-----------|------|--------|--|----|
| | Depth (m) | Type | Results | | | | | | |
| | | | | 0.30 | | | | MADE GROUND: Soft grey brown CLAY with brick | |
| | 1.00 | SPT | N=18 (1,2/3,2,5,8) | 1.00 | | | | MADE GROUND: CONCRETE SLAB 0.7m X 0.3m X 0.3m | 1 |
| | 2.00 | SPT | N=30 (1,7/9,6,6,9) | | | | | MADE GROUND: Firm gravelly cobbly CLAY with brick and concrete fragments | 2 |
| ▼ | 3.00 | SPT | N=13 (1,3/4,4,2,3) | 2.90 | | | | MADE GROUND: Medium dense GRAVEL of ASH and SLAG | 3 |
| | 4.00 | SPT | N=9 (1,2/2,2,2,3) | 3.20 | | | | MADE GROUND: Firm grey mottled CLAY | 4 |
| | 5.00 | SPT | N=6 (1,1/1,1,2,2) | 5.20 | | | | Soft becoming very soft grey silty CLAY (Alluvium) | 5 |
| | 6.50 | SPT | N=0 (0,0/0,0,0,0) | | | | | | 6 |
| | 8.00 | SPT | N=11 (1,1/2,2,3,4) | 7.90 | | | | Firm brown PEAT | 8 |
| | 9.50 | SPT | N=4 (1,0/1,1,1,1) | 8.80 | | | | Very soft grey peaty CLAY (Alluvium) | 9 |
| | | | | | | | | Continued on Next Sheet | 10 |

| Chiseling | Depth Top (m) | Depth Base (m) | Duration (hh:mm) | Remarks |
|-----------|---------------|----------------|------------------|---------|
| | | | | |

Remarks:



Tel: 02920 735354
 info@terrafirmawales.co.uk
 www.terrafirmawales.co.uk

Terra Firma (Wales) Limited
 5 Deryn Court, Wharfedale Road
 Pentwyn, Cardiff
 CF23 7HA

Borehole No.

BH1

Sheet 2 of 2

| | | | |
|------------------------------------|---------------------|----------|--------------|
| Project Name: Herbert Road Phase 1 | Project No: 12032P1 | Co-ords: | Hole Type CP |
|------------------------------------|---------------------|----------|--------------|

| | | |
|-------------------|--------|------------|
| Location: Newport | Level: | Scale 1:54 |
|-------------------|--------|------------|

| | | |
|------------------|---------------------|-----------|
| Client: Keepmoat | Dates: 08/02/2017 - | Logged By |
|------------------|---------------------|-----------|

| Water Strikes | Sample and In Situ Testing | | | Depth (m) | Level (m) | Well | Legend | Stratum Description | |
|---------------|----------------------------|------|-----------------------------|-----------|-----------|------|--------|--|----|
| | Depth (m) | Type | Results | | | | | | |
| | 11.00 | SPT | N=10 (1,2/2,2,3,3) | 10.70 | | | | Firm brown PEAT | 11 |
| | | | | 11.60 | | | | Very soft grey silty CLAY (Alluvium) | 12 |
| | 12.50 | SPT | N=0 (0,0/0,0,0,0) | | | | | | 13 |
| | | | | 13.50 | | | | Soft grey peaty CLAY (Alluvium) | |
| | 14.00 | SPT | N=8 (1,0/1,2,2,3) | 14.20 | | | | Brown PEAT | 14 |
| | | | | 14.60 | | | | Stiff red silty CLAY | |
| | 15.00 | SPT | N=20 (2,2/4,4,5,7) | | | | | | 15 |
| | | | | 16.30 | | | | | 16 |
| | 16.50 | SPT | 50 (25 for 48mm/50 for 2mm) | 16.50 | | | | Very dense red fine to coarse GRAVEL of mudstone | |
| | 16.80 | SPT | 0 (50 for 32mm/0 for 75mm) | 16.80 | | | | Weathered red MUDSTONE | |
| | | | | | | | | End of Borehole at 16.800m | 17 |
| | | | | | | | | | 18 |
| | | | | | | | | | 19 |
| | | | | | | | | | 20 |

| | | | | |
|-----------|---------------|----------------|------------------|---------|
| Chiseling | Depth Top (m) | Depth Base (m) | Duration (hh:mm) | Remarks |
| | 16.50 | 16.80 | 01:00 | |

Remarks:



Tel: 02920 735354
 info@terrafirmawales.co.uk
 www.terrafirmawales.co.uk

Terra Firma (Wales) Limited
 5 Deryn Court, Wharfedale Road
 Pentwyn, Cardiff
 CF23 7HA

Borehole No.

BH2

Sheet 1 of 2

| | | | |
|------------------------------------|---------------------|----------|--------------|
| Project Name: Herbert Road Phase 1 | Project No: 12032P1 | Co-ords: | Hole Type CP |
|------------------------------------|---------------------|----------|--------------|

| | | |
|-------------------|--------|------------|
| Location: Newport | Level: | Scale 1:54 |
|-------------------|--------|------------|

| | | |
|------------------|---------------------|-----------|
| Client: Keepmoat | Dates: 10/02/2017 - | Logged By |
|------------------|---------------------|-----------|

| Water Strikes | Sample and In Situ Testing | | | Depth (m) | Level (m) | Well | Legend | Stratum Description | |
|---------------|----------------------------|------|--------------------|-----------|-----------|------|--------|---|----|
| | Depth (m) | Type | Results | | | | | | |
| | | | | 0.60 | | | | MADE GROUND: Soft grey brown CLAY with brick | |
| | 1.00 | SPT | N=15 (3,2/4,4,6,1) | | | | | MADE GROUND: Medium dense becoming dense GRAVEL of mudstone | 1 |
| | 2.00 | SPT | N=23 (2,4/7,8,8,0) | | | | | | 2 |
| | 3.00 | SPT | N=8 (1,2/3,2,1,2) | 2.80 | | | | MADE GROUND: Soft grey brown CLAY. Brick. | 3 |
| | 4.00 | SPT | N=4 (1,0/0,1,2,1) | 3.40 | | | | MADE GROUND: Very loose gravelly ASH | 4 |
| | 5.00 | SPT | N=4 (1,0/0,0,1,3) | | | | | | 5 |
| | 6.00 | SPT | N=5 (1,2/2,1,1,1) | 5.40 | | | | soft becoming very soft grey silty CLAY (Alluvium) | 6 |
| | 7.50 | SPT | N=1 (1,0/0,1,0,0) | | | | | | 7 |
| | 9.00 | SPT | N=6 (1,2/2,2,2,0) | 8.60 | | | | Brown PEAT | 9 |
| | | | | 9.50 | | | | Soft grey silty CLAY (Alluvium) | |
| | | | | | | | | Continued on Next Sheet | 10 |

| Chiseling | Depth Top (m) | Depth Base (m) | Duration (hh:mm) | Remarks |
|-----------|---------------|----------------|------------------|---------|
| | | | | |

Remarks:



Tel: 02920 735354
 info@terrafirmawales.co.uk
 www.terrafirmawales.co.uk

Terra Firma (Wales) Limited
 5 Deryn Court, Wharfedale Road
 Pentwyn, Cardiff
 CF23 7HA

Borehole No.

BH2

Sheet 2 of 2

| | | | |
|------------------------------------|---------------------|----------|--------------|
| Project Name: Herbert Road Phase 1 | Project No: 12032P1 | Co-ords: | Hole Type CP |
|------------------------------------|---------------------|----------|--------------|

| | | |
|-------------------|--------|------------|
| Location: Newport | Level: | Scale 1:54 |
|-------------------|--------|------------|

| | | |
|------------------|---------------------|-----------|
| Client: Keepmoat | Dates: 10/02/2017 - | Logged By |
|------------------|---------------------|-----------|

| Water Strikes | Sample and In Situ Testing | | | Depth (m) | Level (m) | Well | Legend | Stratum Description | |
|---------------|----------------------------|------|------------------------------|----------------|-----------|------|--------|---|----|
| | Depth (m) | Type | Results | | | | | | |
| | 10.50 | SPT | N=10 (1,0/1,1,1,7) | 10.10 10.70 | | | | Soft brown PEAT | |
| | 12.00 | SPT | N=10 (0,0/0,0,0,10) | | | | | Very soft grey silty CLAY (Alluvium) | 11 |
| | 13.50 | SPT | 0 (0,0/0,0,0,) | | | | | | 12 |
| | | | | | | | | | 13 |
| | | | | | | | | | 14 |
| | 14.40 14.70 | | | | | | | Soft brown PEAT | |
| | 15.00 | SPT | 13 (1,2/3,4,6,) | | | | | Firm becoming stiff red CLAY | 15 |
| | | | | | | | | | 16 |
| ▼ | 16.50 | SPT | 22 (2,6/7,7,8,) | 16.20 | | | | Dense red fine to coarse GRAVEL of mudstone | 17 |
| | 17.30 | SPT | 50 (25 for 75mm/50 for 20mm) | 17.30 | | | | Weathered red SANDSTONE | |
| | 17.60 | SPT | 0 (50 for 0mm/0 for 0mm) | 17.60 | | | | End of Borehole at 17.600m | 18 |
| | | | | | | | | | 19 |
| | | | | | | | | | 20 |

| | | | | |
|-----------|---------------|----------------|------------------|---------|
| Chiseling | Depth Top (m) | Depth Base (m) | Duration (hh:mm) | Remarks |
| | 17.30 | 17.60 | 01:00 | |

Remarks:



Tel: 02920 735354
 info@terrafirmawales.co.uk
 www.terrafirmawales.co.uk

Terra Firma (Wales) Limited
 5 Deryn Court, Wharfedale Road
 Pentwyn, Cardiff
 CF23 7HA

Borehole No.

BH3

Sheet 1 of 2

| | | | |
|------------------------------------|---------------------|----------|--------------|
| Project Name: Herbert Road Phase 1 | Project No: 12032P1 | Co-ords: | Hole Type CP |
| Location: Newport | Level: | | Scale 1:54 |
| Client: Keepmoat | Dates: 13/02/2017 - | | Logged By |

| Water Strikes | Sample and In Situ Testing | | | Depth (m) | Level (m) | Well | Legend | Stratum Description | |
|---------------|----------------------------|------|--------------------|-----------|-----------|------|--------|--|----|
| | Depth (m) | Type | Results | | | | | | |
| | 1.00 | SPT | N=23 (3,7/5,5,6,7) | | | | | MADE GROUND: Firm becoming grey brown CLAY with brick and concrete | 1 |
| | 2.00 | SPT | N=7 (2,2/1,0,3,3) | | | | | | 2 |
| ▼ | 3.00 | SPT | N=2 (1,0/0,0,1,1) | 2.90 | | | | MADE GROUND: Very loose clayey ASH | 3 |
| | 4.00 | SPT | N=2 (1,0/1,0,0,1) | | | | | | 4 |
| | 5.00 | SPT | N=5 (1,0/0,1,2,2) | 5.20 | | | | Soft grey silty CLAY (Alluvium) | 5 |
| | 6.00 | SPT | N=8 (1,1/2,2,2,2) | | | | | | 6 |
| | 7.50 | SPT | N=7 (1,1/1,2,2,2) | 8.10 | | | | Soft brown PEAT | 8 |
| | 9.00 | SPT | N=5 (1,2/2,1,1,1) | 9.20 | | | | Soft grey peaty CLAY | 9 |
| | | | | 9.90 | | | | Continued on Next Sheet | 10 |

| Chiseling | Depth Top (m) | Depth Base (m) | Duration (hh:mm) | Remarks |
|-----------|---------------|----------------|------------------|---------|
| | | | | |

Remarks:



Tel: 02920 735354
 info@terrafirmawales.co.uk
 www.terrafirmawales.co.uk

Terra Firma (Wales) Limited
 5 Deryn Court, Wharfedale Road
 Pentwyn, Cardiff
 CF23 7HA

Borehole No.

BH3

Sheet 2 of 2

| | | | |
|------------------------------------|---------------------|----------|--------------|
| Project Name: Herbert Road Phase 1 | Project No: 12032P1 | Co-ords: | Hole Type CP |
| Location: Newport | Level: | | Scale 1:54 |
| Client: Keepmoat | Dates: 13/02/2017 - | | Logged By |

| Water Strikes | Sample and In Situ Testing | | | Depth (m) | Level (m) | Well | Legend | Stratum Description | |
|---------------|----------------------------|------|------------------------------|-----------|-----------|------|--------|---|----|
| | Depth (m) | Type | Results | | | | | | |
| | 10.50 | SPT | N=3 (1,2/1,1,1,0) | 10.50 | | | | Soft brown PEAt | |
| | | | | | | | | Very soft grey peaty CLAY (Alluvium) | 11 |
| | 12.00 | SPT | N=0 (0,0/0,0,0,0) | 12.00 | | | | Very soft grey CLAY (Alluvium) | 12 |
| | | | | | | | | Very soft grey peaty CLAY (Alluvium) | 13 |
| | 13.50 | SPT | N=1 (1,0/0,1,0,0) | 13.30 | | | | Very soft grey peaty CLAY (Alluvium) | 14 |
| | | | | | | | | Firm red silty CLAY | 15 |
| | 15.00 | SPT | N=14 (1,2/3,3,4,4) | 14.80 | | | | Firm red silty CLAY | 16 |
| ▼ | 16.50 | SPT | N=32 (3,5/6,8,8,10) | 16.20 | | | | Dense red fine to coarse GRAVEL and occasional COBBLE of mudstone | 17 |
| | 18.00 | SPT | 50 (11 for 75mm/50 for 44mm) | 17.90 | | | | Weathered red SANDSTONE | 18 |
| | 18.30 | SPT | 50 (25 for 40mm/50 for 23mm) | 18.30 | | | | End of Borehole at 18.300m | 19 |
| | | | | | | | | | 20 |

| | | | | |
|-----------|---------------|----------------|------------------|---------|
| Chiseling | Depth Top (m) | Depth Base (m) | Duration (hh:mm) | Remarks |
| | 18.00 | 18.30 | 01:00 | |

Remarks:



Tel: 02920 735354
 info@terrafirmawales.co.uk
 www.terrafirmawales.co.uk

Terra Firma (Wales) Limited
 5 Deryn Court, Wharfedale Road
 Pentwyn, Cardiff
 CF23 7HA

Borehole No.

BH4

Sheet 1 of 2

| | | | |
|------------------------------------|---------------------|----------|--------------|
| Project Name: Herbert Road Phase 1 | Project No: 12032P1 | Co-ords: | Hole Type CP |
| Location: Newport | Level: | | Scale 1:54 |
| Client: Keepmoat | Dates: 06/02/2017 - | | Logged By |

| Water Strikes | Sample and In Situ Testing | | | Depth (m) | Level (m) | Well | Legend | Stratum Description | |
|---------------|----------------------------|------|---------------------|-----------|-----------|------|--------|---|---|
| | Depth (m) | Type | Results | | | | | | |
| | 1.00 | SPT | N=25 (3,4/4,5,10,6) | | | | | MADE GROUND: Firm and soft in places CLAY FILL with BRICK | 1 |
| | 2.00 | SPT | N=7 (1,1/2,2,1,2) | | | | | | 2 |
| ▼ | 3.00 | SPT | N=11 (2,3/4,3,3,1) | | | | | | 3 |
| | 4.00 | SPT | N=15 (1,2/4,4,3,4) | 3.90 | | | | MADE GROUND: GRAVEL, BRICK, SLAG and ASH | 4 |
| | 5.00 | SPT | N=6 (2,4/2,2,1,1) | 5.30 | | | | Soft becoming very soft grey CLAY (Alluvium) | 5 |
| | 6.00 | SPT | N=6 (1,0/1,1,2,2) | | | | | | 6 |
| | 7.50 | SPT | N=4 (1,0/0,1,1,2) | 8.20 | | | | Soft brown PEAT | 8 |
| | 9.00 | SPT | N=0 (0,0/0,0,0,0) | 8.90 | | | | Very soft grey peaty CLAY (Alluvium) | 9 |
| | Continued on Next Sheet | | | | | | | | |

| | | | | |
|-----------|---------------|----------------|------------------|---------|
| Chiseling | Depth Top (m) | Depth Base (m) | Duration (hh:mm) | Remarks |
| | | | | |

Remarks:



Tel: 02920 735354
 info@terrafirmawales.co.uk
 www.terrafirmawales.co.uk

Terra Firma (Wales) Limited
 5 Deryn Court, Wharfedale Road
 Pentwyn, Cardiff
 CF23 7HA

Borehole No.

BH4

Sheet 2 of 2

| | | | |
|------------------------------------|---------------------|----------|--------------|
| Project Name: Herbert Road Phase 1 | Project No: 12032P1 | Co-ords: | Hole Type CP |
|------------------------------------|---------------------|----------|--------------|

| | | |
|-------------------|--------|------------|
| Location: Newport | Level: | Scale 1:54 |
|-------------------|--------|------------|

| | | |
|------------------|---------------------|-----------|
| Client: Keepmoat | Dates: 06/02/2017 - | Logged By |
|------------------|---------------------|-----------|

| Water Strikes | Sample and In Situ Testing | | | Depth (m) | Level (m) | Well | Legend | Stratum Description | |
|---------------|----------------------------|------|----------------------------|----------------|-----------|------|--------|---|----|
| | Depth (m) | Type | Results | | | | | | |
| | 10.50 | SPT | N=9 (1,2/3,3,2,1) | 10.10 10.70 | | | | Firm brown PEAT | |
| | 12.00 | SPT | N=0 (0,0/0,0,0,0) | | | | | Very soft to soft grey peaty CLAY (Alluvium) | 11 |
| | 13.50 | SPT | N=6 (1,0/1,1,2,2) | | | | | | 12 |
| | 15.00 | SPT | N=20 (2,3/4,4,5,7) | 14.70 | | | | Stiff red silty CLAY | 13 |
| | 16.00 | SPT | N=26 (2,4/5,5,7,9) | 15.60 15.90 | | | | Firm red gravelly silty CLAY | 14 |
| | 17.50 | SPT | N=31 (1,3/5,7,9,10) | | | | | Medium dense becoming dense red fine to coarse GRAVEL and occasional COBBLE of mudstone | 15 |
| | 18.60 | SPT | 0 (75 for 140mm/0 for 0mm) | 18.60 | | | | Weathered red/purple red MUDSTONE | 16 |
| | 19.00 | SPT | 0 (75 for 68mm/0 for 0mm) | 19.00 | | | | End of Borehole at 19.000m | 17 |
| | | | | | | | | | 18 |
| | | | | | | | | | 19 |
| | | | | | | | | | 20 |

| | | | | |
|-----------|---------------|----------------|------------------|---------|
| Chiseling | Depth Top (m) | Depth Base (m) | Duration (hh:mm) | Remarks |
| | 18.60 | 19.00 | 01:00 | |

Remarks:

ANNEX F
Laboratory Soil and Leachate Chemical
Test Results



DETS

Certificate of Analysis

Certificate Number 17-90179-1

15-Feb-17

Client Terra Firma (Wales) Ltd
5 Deryn Court
Wharfdale Road
Pentwyn
Cardiff
CF23 7HB

Our Reference 17-90179-1

Client Reference 12032P1

Order No (not supplied)

Contract Title H.Rd

Description 12 Soil samples, 1 Leachate sample.

Date Received 31-Jan-17

Date Started 31-Jan-17

Date Completed 15-Feb-17

Test Procedures Identified by prefix DETSn (details on request).

Notes **This report supersedes 17-90179, Extra Testing**

Opinions and interpretations are outside the scope of UKAS accreditation. This certificate is issued in accordance with the accreditation requirements of the United Kingdom Accreditation Service. The results reported herein relate only to the material supplied to the laboratory. Observations and interpretations are outside the scope of ISO 17025. This certificate shall not be reproduced except in full, without the prior written approval of the laboratory.

Approved By



Rob Brown
Business Manager



Summary of Chemical Analysis

Matrix Descriptions

Our Ref 17-90179-1

Client Ref 12032P1

Contract Title H.Rd

| Sample ID | Depth | Lab No | Completed | Matrix Description |
|-----------|-------|---------|------------|--|
| TP1 | 0.3 | 1118242 | 08/02/2017 | Brown gravelly, sandy CLAY |
| TP2 | 0.6 | 1118243 | 08/02/2017 | Dark brown gravelly, sandy CLAY (Made ground - brick) |
| TP3 | 0.2 | 1118244 | 08/02/2017 | Brown gravelly, sandy CLAY including odd rootlets |
| TP4 | 0.5 | 1118245 | 08/02/2017 | Brown gravelly, sandy CLAY |
| TP5 | 0.3 | 1118246 | 08/02/2017 | Dark brown gravelly, sandy CLAY (Made ground - brick,glass) |
| TP6 | 0.4 | 1118247 | 08/02/2017 | Brown gravelly, sandy CLAY |
| TP7 | 0.2 | 1118248 | 08/02/2017 | Brown gravelly, sandy CLAY including numerous rootlets |
| TP8 | 0.6 | 1118249 | 08/02/2017 | Dark brown gravelly, sandy CLAY |
| TP9 | 0.4 | 1118250 | 08/02/2017 | Brown gravelly, sandy CLAY (Made ground - brick) |
| TP10 | 0.2 | 1118251 | 08/02/2017 | Brown gravelly, sandy CLAY including odd rootlets |
| TP11 | 0.5 | 1118252 | 08/02/2017 | Dark grey gravelly, sandy CLAY including odd rootlets (Possible made ground - brick) |
| TP12 | 0.3 | 1118253 | 08/02/2017 | Brown gravelly, sandy CLAY (Possible made ground - brick) |

Summary of Chemical Analysis

Soil Samples

Our Ref 17-90179-1

Client Ref 12032P1

Contract Title H.Rd

| Lab No | 1118242 | 1118243 | 1118244 | 1118245 | 1118246 | 1118247 |
|---------------|----------|----------|----------|----------|----------|----------|
| Sample ID | TP1 | TP2 | TP3 | TP4 | TP5 | TP6 |
| Depth | 0.30 | 0.60 | 0.20 | 0.50 | 0.30 | 0.40 |
| Other ID | | | | | | |
| Sample Type | SOIL | SOIL | SOIL | SOIL | SOIL | SOIL |
| Sampling Date | 30/01/17 | 30/01/17 | 30/01/17 | 30/01/17 | 30/01/17 | 30/01/17 |
| Sampling Time | n/s | n/s | n/s | n/s | n/s | n/s |

| Test | Method | LOD | Units | | | | | | |
|-------------------------|-------------|------|-------|--------|-------|--------|--------|--------|--------|
| Metals | | | | | | | | | |
| Arsenic | DETSC 2301# | 0.2 | mg/kg | 12 | 32 | 15 | 4.6 | 15 | 9.6 |
| Cadmium | DETSC 2301# | 0.1 | mg/kg | 0.5 | 3.2 | 0.8 | 0.2 | 0.4 | 0.4 |
| Chromium | DETSC 2301# | 0.15 | mg/kg | 20 | 38 | 20 | 8.4 | 25 | 18 |
| Chromium III | DETSC 2301* | 0.15 | mg/kg | 20 | 38 | 20 | 8.4 | 25 | 18 |
| Chromium, Hexavalent | DETSC 2204* | 1 | mg/kg | < 1.0 | < 1.0 | < 1.0 | < 1.0 | < 1.0 | < 1.0 |
| Copper | DETSC 2301# | 0.2 | mg/kg | 51 | 110 | 50 | 39 | 50 | 39 |
| Lead | DETSC 2301# | 0.3 | mg/kg | 180 | 470 | 110 | 27 | 90 | 57 |
| Mercury | DETSC 2325# | 0.05 | mg/kg | 0.26 | 0.66 | 0.25 | 0.07 | 0.18 | 0.14 |
| Nickel | DETSC 2301# | 1 | mg/kg | 20 | 39 | 19 | 5.6 | 27 | 15 |
| Selenium | DETSC 2301# | 0.5 | mg/kg | 0.7 | 0.7 | < 0.5 | 1.6 | 0.7 | 0.6 |
| Zinc | DETSC 2301# | 1 | mg/kg | 110 | 250 | 94 | 46 | 120 | 84 |
| Inorganics | | | | | | | | | |
| pH | DETSC 2008# | | | 8.5 | 9.3 | 8.7 | 9.5 | 10.0 | 9.9 |
| Cyanide, Total | DETSC 2130# | 0.1 | mg/kg | 0.1 | 0.2 | 0.1 | < 0.1 | 0.5 | 0.3 |
| Organic matter | DETSC 2002# | 0.1 | % | 3.7 | 5.9 | 4.4 | 1.0 | 3.8 | 3.7 |
| Sulphate as SO4, Total | DETSC 2321# | 0.01 | % | 0.14 | 0.16 | 0.11 | 0.18 | 0.14 | 0.16 |
| PAHs | | | | | | | | | |
| Naphthalene | DETSC 3303# | 0.03 | mg/kg | < 0.03 | 0.06 | < 0.03 | < 0.03 | < 0.03 | < 0.03 |
| Acenaphthylene | DETSC 3303# | 0.03 | mg/kg | 0.03 | 0.04 | < 0.03 | < 0.03 | 0.06 | < 0.03 |
| Acenaphthene | DETSC 3303# | 0.03 | mg/kg | 0.13 | 0.10 | < 0.03 | < 0.03 | < 0.03 | < 0.03 |
| Fluorene | DETSC 3303 | 0.03 | mg/kg | 0.10 | 0.08 | < 0.03 | < 0.03 | < 0.03 | < 0.03 |
| Phenanthrene | DETSC 3303# | 0.03 | mg/kg | 0.70 | 0.30 | 0.19 | 0.09 | 0.19 | 0.08 |
| Anthracene | DETSC 3303 | 0.03 | mg/kg | 0.14 | 0.06 | 0.05 | < 0.03 | 0.05 | < 0.03 |
| Fluoranthene | DETSC 3303# | 0.03 | mg/kg | 1.1 | 0.50 | 0.52 | 0.22 | 0.48 | 0.19 |
| Pyrene | DETSC 3303# | 0.03 | mg/kg | 0.92 | 0.44 | 0.47 | 0.19 | 0.49 | 0.18 |
| Benzo(a)anthracene | DETSC 3303# | 0.03 | mg/kg | 0.50 | 0.25 | 0.30 | 0.14 | 0.29 | 0.13 |
| Chrysene | DETSC 3303 | 0.03 | mg/kg | 0.55 | 0.28 | 0.30 | 0.14 | 0.31 | 0.15 |
| Benzo(b)fluoranthene | DETSC 3303# | 0.03 | mg/kg | 0.79 | 0.35 | 0.50 | 0.24 | 0.47 | 0.20 |
| Benzo(k)fluoranthene | DETSC 3303# | 0.03 | mg/kg | 0.26 | 0.13 | 0.16 | 0.09 | 0.14 | 0.06 |
| Benzo(a)pyrene | DETSC 3303# | 0.03 | mg/kg | 0.56 | 0.23 | 0.31 | 0.15 | 0.34 | 0.14 |
| Indeno(1,2,3-c,d)pyrene | DETSC 3303# | 0.03 | mg/kg | 0.30 | 0.11 | 0.16 | 0.09 | 0.16 | 0.12 |
| Dibenzo(a,h)anthracene | DETSC 3303# | 0.03 | mg/kg | 0.09 | 0.04 | 0.05 | < 0.03 | 0.05 | < 0.03 |
| Benzo(g,h,i)perylene | DETSC 3303# | 0.03 | mg/kg | 0.33 | 0.11 | 0.17 | 0.10 | 0.16 | 0.12 |
| PAH - USEPA 16, Total | DETSC 3303 | 0.1 | mg/kg | 6.5 | 3.1 | 3.2 | 1.5 | 3.2 | 1.4 |
| Phenols | | | | | | | | | |
| Phenol - Monohydric | DETSC 2130# | 0.3 | mg/kg | < 0.3 | 0.5 | < 0.3 | < 0.3 | < 0.3 | < 0.3 |

Summary of Chemical Analysis

Soil Samples

Our Ref 17-90179-1

Client Ref 12032P1

Contract Title H.Rd

| Lab No | 1118248 | 1118249 | 1118250 | 1118251 | 1118252 | 1118253 |
|---------------|----------|----------|----------|----------|----------|----------|
| Sample ID | TP7 | TP8 | TP9 | TP10 | TP11 | TP12 |
| Depth | 0.20 | 0.60 | 0.40 | 0.20 | 0.50 | 0.30 |
| Other ID | | | | | | |
| Sample Type | SOIL | SOIL | SOIL | SOIL | SOIL | SOIL |
| Sampling Date | 30/01/17 | 30/01/17 | 30/01/17 | 30/01/17 | 30/01/17 | 30/01/17 |
| Sampling Time | n/s | n/s | n/s | n/s | n/s | n/s |

| Test | Method | LOD | Units | | | | | | |
|-------------------------|-------------|------|-------|--------|--------|--------|--------|--------|--------|
| Metals | | | | | | | | | |
| Arsenic | DETSC 2301# | 0.2 | mg/kg | 18 | 12 | 17 | 13 | 20 | 11 |
| Cadmium | DETSC 2301# | 0.1 | mg/kg | 1.0 | 0.6 | 0.9 | 0.1 | 0.8 | 0.4 |
| Chromium | DETSC 2301# | 0.15 | mg/kg | 40 | 23 | 26 | 32 | 19 | 16 |
| Chromium III | DETSC 2301* | 0.15 | mg/kg | 40 | 23 | 26 | 32 | 19 | 16 |
| Chromium, Hexavalent | DETSC 2204* | 1 | mg/kg | < 1.0 | < 1.0 | < 1.0 | < 1.0 | < 1.0 | < 1.0 |
| Copper | DETSC 2301# | 0.2 | mg/kg | 44 | 51 | 81 | 22 | 42 | 33 |
| Lead | DETSC 2301# | 0.3 | mg/kg | 84 | 200 | 140 | 41 | 200 | 80 |
| Mercury | DETSC 2325# | 0.05 | mg/kg | 0.36 | 0.16 | 0.29 | 0.05 | 0.30 | 0.21 |
| Nickel | DETSC 2301# | 1 | mg/kg | 33 | 24 | 28 | 28 | 17 | 17 |
| Selenium | DETSC 2301# | 0.5 | mg/kg | 0.6 | 0.8 | 0.6 | < 0.5 | < 0.5 | 0.5 |
| Zinc | DETSC 2301# | 1 | mg/kg | 210 | 200 | 150 | 87 | 180 | 88 |
| Inorganics | | | | | | | | | |
| pH | DETSC 2008# | | | 8.2 | 8.5 | 9.9 | 8.2 | 10.2 | 9.2 |
| Cyanide, Total | DETSC 2130# | 0.1 | mg/kg | 0.1 | 0.2 | 0.2 | < 0.1 | 0.2 | 0.1 |
| Organic matter | DETSC 2002# | 0.1 | % | 6.8 | 2.6 | 4.9 | 2.0 | 3.8 | 1.0 |
| Sulphate as SO4, Total | DETSC 2321# | 0.01 | % | 0.11 | 0.12 | 0.10 | 0.04 | 0.27 | 0.13 |
| PAHs | | | | | | | | | |
| Naphthalene | DETSC 3303# | 0.03 | mg/kg | < 0.03 | < 0.03 | < 0.03 | < 0.03 | < 0.03 | < 0.03 |
| Acenaphthylene | DETSC 3303# | 0.03 | mg/kg | < 0.03 | 0.05 | < 0.03 | < 0.03 | < 0.03 | < 0.03 |
| Acenaphthene | DETSC 3303# | 0.03 | mg/kg | < 0.03 | 0.07 | < 0.03 | < 0.03 | < 0.03 | < 0.03 |
| Fluorene | DETSC 3303 | 0.03 | mg/kg | < 0.03 | 0.07 | < 0.03 | < 0.03 | < 0.03 | < 0.03 |
| Phenanthrene | DETSC 3303# | 0.03 | mg/kg | 0.07 | 0.65 | 0.19 | 0.11 | 0.24 | 0.23 |
| Anthracene | DETSC 3303 | 0.03 | mg/kg | < 0.03 | 0.16 | 0.05 | < 0.03 | 0.05 | 0.06 |
| Fluoranthene | DETSC 3303# | 0.03 | mg/kg | 0.10 | 1.9 | 0.41 | 0.24 | 0.47 | 0.42 |
| Pyrene | DETSC 3303# | 0.03 | mg/kg | 0.07 | 1.8 | 0.40 | 0.22 | 0.39 | 0.36 |
| Benzo(a)anthracene | DETSC 3303# | 0.03 | mg/kg | < 0.03 | 0.68 | 0.22 | 0.12 | 0.22 | 0.25 |
| Chrysene | DETSC 3303 | 0.03 | mg/kg | < 0.03 | 0.53 | 0.24 | 0.14 | 0.26 | 0.25 |
| Benzo(b)fluoranthene | DETSC 3303# | 0.03 | mg/kg | < 0.03 | 0.64 | 0.35 | 0.16 | 0.31 | 0.34 |
| Benzo(k)fluoranthene | DETSC 3303# | 0.03 | mg/kg | < 0.03 | 0.20 | 0.11 | 0.05 | 0.07 | 0.11 |
| Benzo(a)pyrene | DETSC 3303# | 0.03 | mg/kg | < 0.03 | 0.44 | 0.22 | 0.11 | 0.17 | 0.23 |
| Indeno(1,2,3-c,d)pyrene | DETSC 3303# | 0.03 | mg/kg | < 0.03 | 0.19 | 0.14 | 0.05 | 0.09 | 0.12 |
| Dibenzo(a,h)anthracene | DETSC 3303# | 0.03 | mg/kg | < 0.03 | 0.06 | < 0.03 | < 0.03 | < 0.03 | < 0.03 |
| Benzo(g,h,i)perylene | DETSC 3303# | 0.03 | mg/kg | < 0.03 | 0.19 | 0.15 | 0.05 | 0.10 | 0.12 |
| PAH - USEPA 16, Total | DETSC 3303 | 0.1 | mg/kg | 0.23 | 7.6 | 2.5 | 1.3 | 2.4 | 2.5 |
| Phenols | | | | | | | | | |
| Phenol - Monohydric | DETSC 2130# | 0.3 | mg/kg | 0.6 | < 0.3 | 0.8 | < 0.3 | < 0.3 | < 0.3 |

Summary of Chemical Analysis

Leachate Samples

Our Ref 17-90179-1

Client Ref 12032P1

Contract Title H.Rd

| | |
|----------------------|----------|
| Lab No | 1125558 |
| Sample ID | TP2 |
| Depth | 0.30 |
| Other ID | |
| Sample Type | LEACHATE |
| Sampling Date | 30/01/17 |
| Sampling Time | n/s |

| Test | Method | LOD | Units |
|--------------------------|------------|------|-----------|
| Preparation | | | |
| NRA Leachate Preparation | DETS 036* | | Y |
| Metals | | | |
| Lead, Dissolved | DETSC 2306 | 0.09 | ug/l 0.27 |

Summary of Asbestos Analysis

Soil Samples

Our Ref 17-90179-1

Client Ref 12032P1

Contract Title H.Rd

| Lab No | Sample ID | Material Type | Result | Comment* | Analyst |
|---------|-----------|---------------|------------|-----------------------------------|---------------|
| 1118242 | TP1 0.30 | SOIL | NAD | none | Colin Patrick |
| 1118243 | TP2 0.60 | SOIL | NAD | none | Colin Patrick |
| 1118244 | TP3 0.20 | SOIL | NAD | none | Colin Patrick |
| 1118245 | TP4 0.50 | SOIL | NAD | none | Colin Patrick |
| 1118246 | TP5 0.30 | SOIL | NAD | none | Colin Patrick |
| 1118247 | TP6 0.40 | SOIL | Chrysotile | small bundle of Chrysotile fibres | Colin Patrick |
| 1118248 | TP7 0.20 | SOIL | NAD | none | Colin Patrick |
| 1118249 | TP8 0.60 | SOIL | NAD | none | Colin Patrick |
| 1118250 | TP9 0.40 | SOIL | NAD | none | Colin Patrick |
| 1118251 | TP10 0.20 | SOIL | NAD | none | Colin Patrick |
| 1118252 | TP11 0.50 | SOIL | NAD | none | Colin Patrick |
| 1118253 | TP12 0.30 | SOIL | NAD | none | Colin Patrick |

Crocidolite = Blue Asbestos, Amosite = Brown Asbestos, Chrysotile = White Asbestos. Anthophyllite, Actinolite and Tremolite are other forms of Asbestos. Samples are analysed by DETSC 1101 using polarised light microscopy in accordance with HSG248 and documented in-house methods. NAD = No Asbestos Detected. Where a sample is NAD, the result is based on analysis of at least 2 sub-samples and should be taken to mean 'no asbestos detected in sample'. Key: * -not included in laboratory scope of accreditation.

Information in Support of the Analytical Results

Our Ref 17-90179-1
 Client Ref 12032P1
 Contract H.Rd

Containers Received & Deviating Samples

| Lab No | Sample ID | Date Sampled | Containers Received | Holding time exceeded for tests | Inappropriate container for tests |
|---------|-------------------|--------------|---------------------|---------------------------------|-----------------------------------|
| 1118242 | TP1 0.30 SOIL | 30/01/17 | GJ 250ml, PT 1L | | |
| 1118243 | TP2 0.60 SOIL | 30/01/17 | GJ 250ml, PT 1L | | |
| 1118244 | TP3 0.20 SOIL | 30/01/17 | GJ 250ml, PT 1L | | |
| 1118245 | TP4 0.50 SOIL | 30/01/17 | GJ 250ml, PT 1L | | |
| 1118246 | TP5 0.30 SOIL | 30/01/17 | GJ 250ml, PT 1L | | |
| 1118247 | TP6 0.40 SOIL | 30/01/17 | GJ 250ml, PT 1L | | |
| 1118248 | TP7 0.20 SOIL | 30/01/17 | GJ 250ml, PT 1L | | |
| 1118249 | TP8 0.60 SOIL | 30/01/17 | GJ 250ml, PT 1L | | |
| 1118250 | TP9 0.40 SOIL | 30/01/17 | GJ 250ml, PT 1L | | |
| 1118251 | TP10 0.20 SOIL | 30/01/17 | GJ 250ml, PT 1L | | |
| 1118252 | TP11 0.50 SOIL | 30/01/17 | GJ 250ml, PT 1L | | |
| 1118253 | TP12 0.30 SOIL | 30/01/17 | GJ 250ml, PT 1L | | |
| 1125558 | TP2 0.30 LEACHATE | 30/01/17 | GJ 1L (1L) | | |

Key: G-Glass P-Plastic J-Jar T-Tub

DETS cannot be held responsible for the integrity of samples received whereby the laboratory did not undertake the sampling. In this instance samples received may be deviating. Deviating Sample criteria are based on British and International standards and laboratory trials in conjunction with the UKAS note 'Guidance on Deviating Samples'. All samples received are listed above. However, those samples that have additional comments in relation to hold time, inappropriate containers etc are deviating due to the reasons stated. This means that the analysis is accredited where applicable, but results may be compromised due to sample deviations. If no sampled date (soils) or date+time (waters) has been supplied then samples are deviating. However, if you are able to supply a sampled date (and time for waters) this will prevent samples being reported as deviating where specific hold times are not exceeded and where the container supplied is suitable.

Soil Analysis Notes

Inorganic soil analysis was carried out on a dried sample, crushed to pass a 425µm sieve, in accordance with BS1377.

Organic soil analysis was carried out on an 'as received' sample. Organics results are corrected for moisture and expressed on a dry weight basis.

The Loss on Drying, used to express organics analysis on an air dried basis, is carried out at a temperature of 28°C +/-2°C.

Disposal

From the issue date of this test certificate, samples will be held for the following times prior to disposal :-

Soils - 1 month, Liquids - 2 weeks, Asbestos (test portion) - 6 months

Appendix A - Details of Analysis

| Method | Parameter | Units | Limit of Detection | Sample Preparation | Sub-Contracted | UKAS | MCERTS |
|------------|--|----------|--------------------|--------------------|----------------|------|--------|
| DETSC 2002 | Organic matter | % | 0.1 | Air Dried | No | Yes | Yes |
| DETSC 2003 | Loss on ignition | % | 0.01 | Air Dried | No | Yes | Yes |
| DETSC 2008 | pH | pH Units | 1 | Air Dried | No | Yes | Yes |
| DETSC 2024 | Sulphide | mg/kg | 10 | Air Dried | No | Yes | Yes |
| DETSC 2076 | Sulphate Aqueous Extract as SO4 | mg/l | 10 | Air Dried | No | Yes | Yes |
| DETSC 2084 | Total Carbon | % | 0.5 | Air Dried | No | Yes | Yes |
| DETSC 2084 | Total Organic Carbon | % | 0.5 | Air Dried | No | Yes | Yes |
| DETSC 2119 | Ammoniacal Nitrogen as N | mg/kg | 0.5 | Air Dried | No | Yes | Yes |
| DETSC 2130 | Cyanide free | mg/kg | 0.1 | Air Dried | No | Yes | Yes |
| DETSC 2130 | Cyanide total | mg/kg | 0.1 | Air Dried | No | Yes | Yes |
| DETSC 2130 | Phenol - Monohydric | mg/kg | 0.3 | Air Dried | No | Yes | Yes |
| DETSC 2130 | Thiocyanate | mg/kg | 0.6 | Air Dried | No | Yes | Yes |
| DETSC 2321 | Total Sulphate as SO4 | % | 0.01 | Air Dried | No | Yes | Yes |
| DETSC 2325 | Mercury | mg/kg | 0.05 | Air Dried | No | Yes | Yes |
| DETSC 3049 | Sulphur (free) | mg/kg | 0.75 | Air Dried | No | Yes | Yes |
| DETSC2123 | Boron (water soluble) | mg/kg | 0.2 | Air Dried | No | Yes | Yes |
| DETSC2301 | Arsenic | mg/kg | 0.2 | Air Dried | No | Yes | Yes |
| DETSC2301 | Barium | mg/kg | 1.5 | Air Dried | No | Yes | Yes |
| DETSC2301 | Beryllium | mg/kg | 0.2 | Air Dried | No | Yes | Yes |
| DETSC2301 | Cadmium Available | mg/kg | 0.1 | Air Dried | No | Yes | Yes |
| DETSC2301 | Cadmium | mg/kg | 0.1 | Air Dried | No | Yes | Yes |
| DETSC2301 | Cobalt | mg/kg | 0.7 | Air Dried | No | Yes | Yes |
| DETSC2301 | Chromium | mg/kg | 0.15 | Air Dried | No | Yes | Yes |
| DETSC2301 | Copper | mg/kg | 0.2 | Air Dried | No | Yes | Yes |
| DETSC2301 | Manganese | mg/kg | 20 | Air Dried | No | Yes | Yes |
| DETSC2301 | Molybdenum | mg/kg | 0.4 | Air Dried | No | Yes | Yes |
| DETSC2301 | Nickel | mg/kg | 1 | Air Dried | No | Yes | Yes |
| DETSC2301 | Lead | mg/kg | 0.3 | Air Dried | No | Yes | Yes |
| DETSC2301 | Selenium | mg/kg | 0.5 | Air Dried | No | Yes | Yes |
| DETSC2301 | Zinc | mg/kg | 1 | Air Dried | No | Yes | Yes |
| DETSC 3072 | Ali/Aro C10-C35 | mg/kg | 10 | As Received | No | Yes | Yes |
| DETSC 3072 | Aliphatic C10-C12 | mg/kg | 1.5 | As Received | No | Yes | Yes |
| DETSC 3072 | Aliphatic C10-C12 | mg/kg | 10 | As Received | No | Yes | Yes |
| DETSC 3072 | Aliphatic C10-C35 | mg/kg | 10 | As Received | No | Yes | Yes |
| DETSC 3072 | Aliphatic C12-C16 | mg/kg | 1.2 | As Received | No | Yes | Yes |
| DETSC 3072 | Aliphatic C12-C16 | mg/kg | 10 | As Received | No | Yes | Yes |
| DETSC 3072 | Aliphatic C16-C21 | mg/kg | 1.5 | As Received | No | Yes | Yes |
| DETSC 3072 | Aliphatic C16-C21 | mg/kg | 10 | As Received | No | Yes | Yes |
| DETSC 3072 | Aliphatic C21-C35 | mg/kg | 3.4 | As Received | No | Yes | Yes |
| DETSC 3072 | Aliphatic C21-C35 | mg/kg | 3.4 | As Received | No | Yes | Yes |
| DETSC 3072 | Aromatic C10-C12 | mg/kg | 0.9 | As Received | No | Yes | Yes |
| DETSC 3072 | Aromatic C10-C12 | mg/kg | 10 | As Received | No | Yes | Yes |
| DETSC 3072 | Aromatic C10-C35 | mg/kg | 10 | As Received | No | Yes | Yes |
| DETSC 3072 | Aromatic C12-C16 | mg/kg | 0.5 | As Received | No | Yes | Yes |
| DETSC 3072 | Aromatic C12-C16 | mg/kg | 10 | As Received | No | Yes | Yes |
| DETSC 3072 | Aromatic C16-C21 | mg/kg | 0.6 | As Received | No | Yes | Yes |
| DETSC 3072 | Aromatic C16-C21 | mg/kg | 10 | As Received | No | Yes | Yes |
| DETSC 3072 | Aromatic C21-C35 | mg/kg | 1.4 | As Received | No | Yes | Yes |
| DETSC 3072 | Aromatic C21-C35 | mg/kg | 1.4 | As Received | No | Yes | Yes |
| DETS 062 | Benzene | mg/kg | 0.01 | As Received | No | Yes | Yes |
| DETS 062 | Ethylbenzene | mg/kg | 0.01 | As Received | No | Yes | Yes |
| DETS 062 | Toluene | mg/kg | 0.01 | As Received | No | Yes | Yes |
| DETS 062 | Xylene | mg/kg | 0.01 | As Received | No | Yes | Yes |
| DETS 062 | m+p Xylene | mg/kg | 0.01 | As Received | No | Yes | Yes |
| DETS 062 | o Xylene | mg/kg | 0.01 | As Received | No | Yes | Yes |
| DETSC 3311 | C10-C24 Diesel Range Organics (DRO) | mg/kg | 10 | As Received | No | Yes | Yes |
| DETSC 3311 | C24-C40 Lube Oil Range Organics (LORO) | mg/kg | 10 | As Received | No | Yes | Yes |
| DETSC 3311 | EPH (C10-C40) | mg/kg | 10 | As Received | No | Yes | Yes |

Appendix A - Details of Analysis

| Method | Parameter | Units | Limit of Detection | Sample Preparation | Sub-Contracted | UKAS | MCERTS |
|------------|-------------------------|-------|--------------------|--------------------|----------------|------|--------|
| DETSC 3303 | Acenaphthene | mg/kg | 0.03 | As Received | No | Yes | Yes |
| DETSC 3303 | Acenaphthylene | mg/kg | 0.03 | As Received | No | Yes | Yes |
| DETSC 3303 | Benzo(a)pyrene | mg/kg | 0.03 | As Received | No | Yes | Yes |
| DETSC 3303 | Benzo(a)anthracene | mg/kg | 0.03 | As Received | No | Yes | Yes |
| DETSC 3303 | Benzo(b)fluoranthene | mg/kg | 0.03 | As Received | No | Yes | Yes |
| DETSC 3303 | Benzo(k)fluoranthene | mg/kg | 0.03 | As Received | No | Yes | Yes |
| DETSC 3303 | Benzo(g,h,i)perylene | mg/kg | 0.03 | As Received | No | Yes | Yes |
| DETSC 3303 | Dibenzo(a,h)anthracene | mg/kg | 0.03 | As Received | No | Yes | Yes |
| DETSC 3303 | Fluoranthene | mg/kg | 0.03 | As Received | No | Yes | Yes |
| DETSC 3303 | Indeno(1,2,3-c,d)pyrene | mg/kg | 0.03 | As Received | No | Yes | Yes |
| DETSC 3303 | Naphthalene | mg/kg | 0.03 | As Received | No | Yes | Yes |
| DETSC 3303 | Phenanthrene | mg/kg | 0.03 | As Received | No | Yes | Yes |
| DETSC 3303 | Pyrene | mg/kg | 0.03 | As Received | No | Yes | Yes |
| DETSC 3401 | PCB 28 + PCB 31 | mg/kg | 0.01 | As Received | No | Yes | Yes |
| DETSC 3401 | PCB 52 | mg/kg | 0.01 | As Received | No | Yes | Yes |
| DETSC 3401 | PCB 101 | mg/kg | 0.01 | As Received | No | Yes | Yes |
| DETSC 3401 | PCB 118 | mg/kg | 0.01 | As Received | No | Yes | Yes |
| DETSC 3401 | PCB 153 | mg/kg | 0.01 | As Received | No | Yes | Yes |
| DETSC 3401 | PCB 138 | mg/kg | 0.01 | As Received | No | Yes | Yes |
| DETSC 3401 | PCB 180 | mg/kg | 0.01 | As Received | No | Yes | Yes |
| DETSC 3401 | PCB Total | mg/kg | 0.01 | As Received | No | Yes | Yes |

Method details are shown only for those determinands listed in Annex A of the MCERTS standard. Anything not included on this list falls outside the scope of MCERTS. No Recovery Factors are used in the determination of results. Results reported assume 100% recovery. Full method statements are available on request.

ANNEX G
Gas Monitoring Results

| | | | | | BH1 | BH2 | BH4 |
|---------------------|-----------------------|----|--|------------------------|-----|------|------|
| Round | 1 | | | % CH ₄ | 0 | 0 | 0 |
| Date | 21.02.2017 | | | % CH ₄ Peak | 0 | 0 | 0 |
| Weather | Overcast with drizzle | | | % LEL | 0 | 0 | 0 |
| Barometric pressure | 1017 | mb | | % CO ₂ | 6.7 | 2.6 | 0.4 |
| | | | | % O ₂ | 9.6 | 12.2 | 19.9 |
| | | | | CO (ppm) | 0 | 0 | 0 |
| | | | | H ₂ S (ppm) | 0 | 0 | 0 |
| | | | | Flow (l/hr) | 0 | 0 | 0 |

DRAWINGS



Drawing Number
01

Drawing Title
SITE LAYOUT

Job Number
12032P1

Job Title
**HERBERT ROAD
NEWPORT**

NOT TO SCALE

